

Thermal Solutions Provider

**HEATSINK**  
**KÜHLKÖRPER**  
**散热产品**

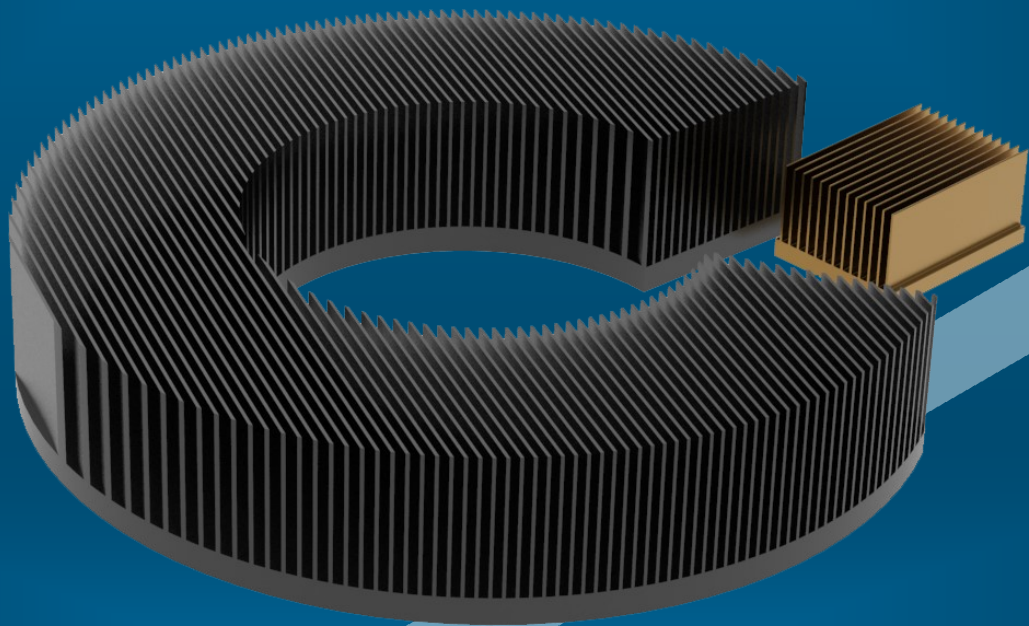

# Green Energy Make You Beautiful Life

## DONGGUAN (东莞)

### Renxin-Seiko Industry Co., Ltd

Tel: +86 769 8182 2159

+ 86 769 8182 2156

+86 769 8182 2158

Fax: + 86 769 8182 2157

Address :#23 Weijian Road, Zone E, Weijian Industrial Park,  
Chashan Town Dongguan City, Guangdong Province, China

## HONG KONG (香港)

### Renxin Seiko (Hong Kong) Limited

Tel: + 00852 2139 3217 FAX: + +00852 2139 3217

Address: 12/F San Tai Building 137-139 Connaught Road Central Hong Kong

Website: [www.renxin-precision.com](http://www.renxin-precision.com)



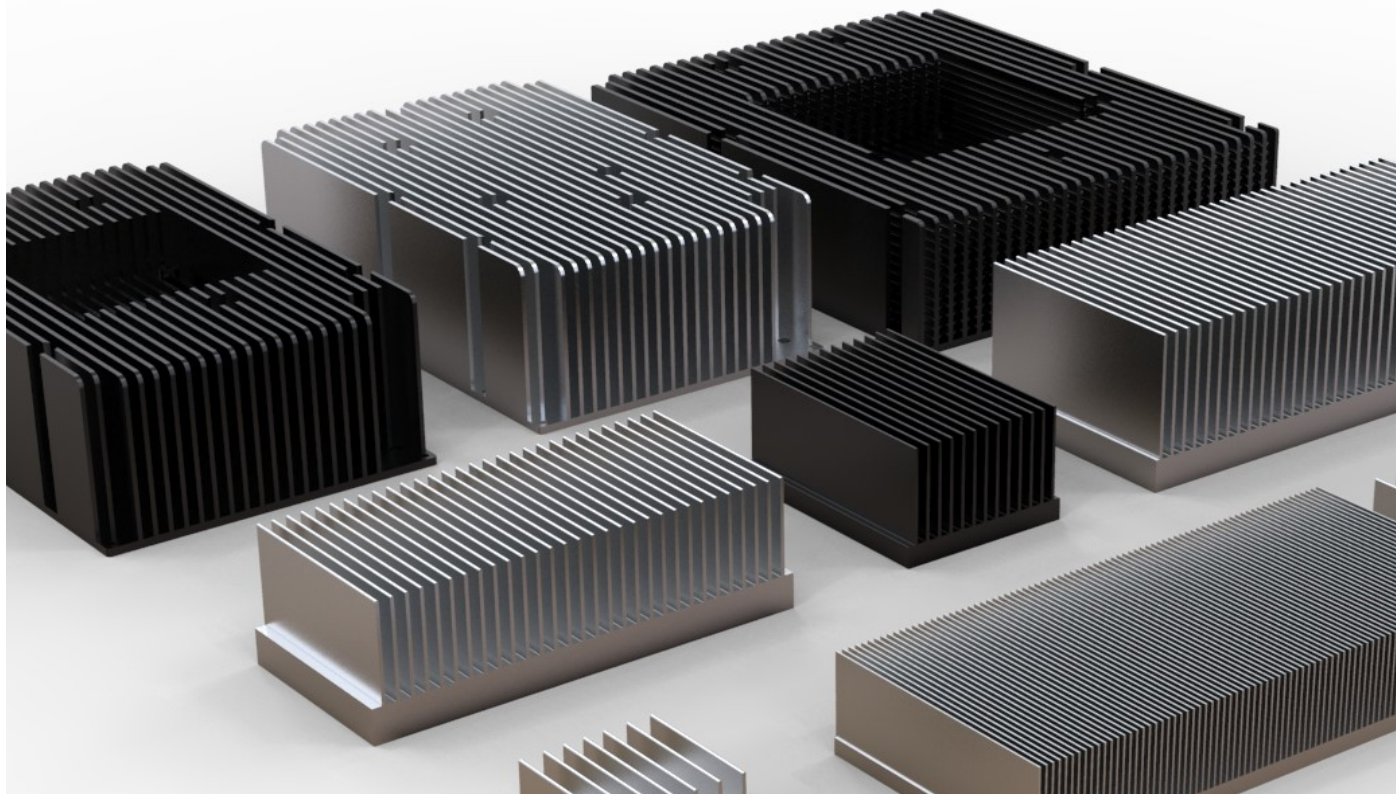

## Extruded Profiles for Heatsink - 1



HEATSINKS WITH SOLDER PIN FOR PCB MOUNTING

P 15- 26



STANDARD EXTRUDED ALUMINUM HEATSINKS

P27-44



ALUMINUM EXTRUSION PROFILE FOR LED'S

P 45-47



EXTRUDED ALUMINUM CASES

P 48-50



EXTRUDED PROFILES FOR ALUMINUM

P

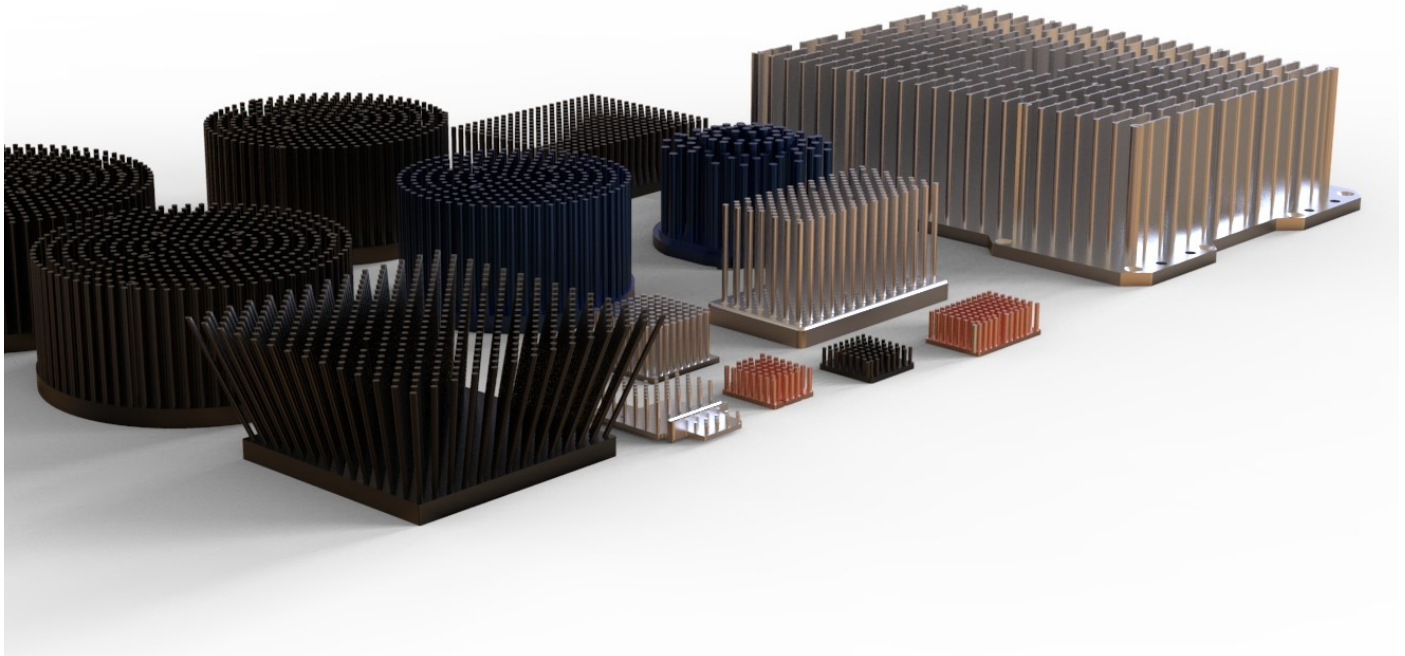

## FORGING HEATSINK FOR ALUMINUM AND CU - 2



*FORGING HEATSINK WITH SOLDER PIN FOR PCB MOUNTING*

*P*



*STANDARD FORGING PIN FIN HEATSINKS*

*P*



*FORGING PIN FIN HEATSINK FOR LED'S*

*P*



*CUSTOMIZED FORGING PIN HEATSINK*

*P*



*SPLAYED PIN HEATSINK*

*P*



### *Cooling Aggregates - 3*



*EXTRUDED HEATSINK WITH FAN COOLING SYSTEM*

*P*



*HOLLOW-FIN COOLING SYSTEM*

*P*



*HIGH CAPACITY COOLING SYSTEM*

*P*



*CUSTOMIZED COOLING SYSTEM*

*P*

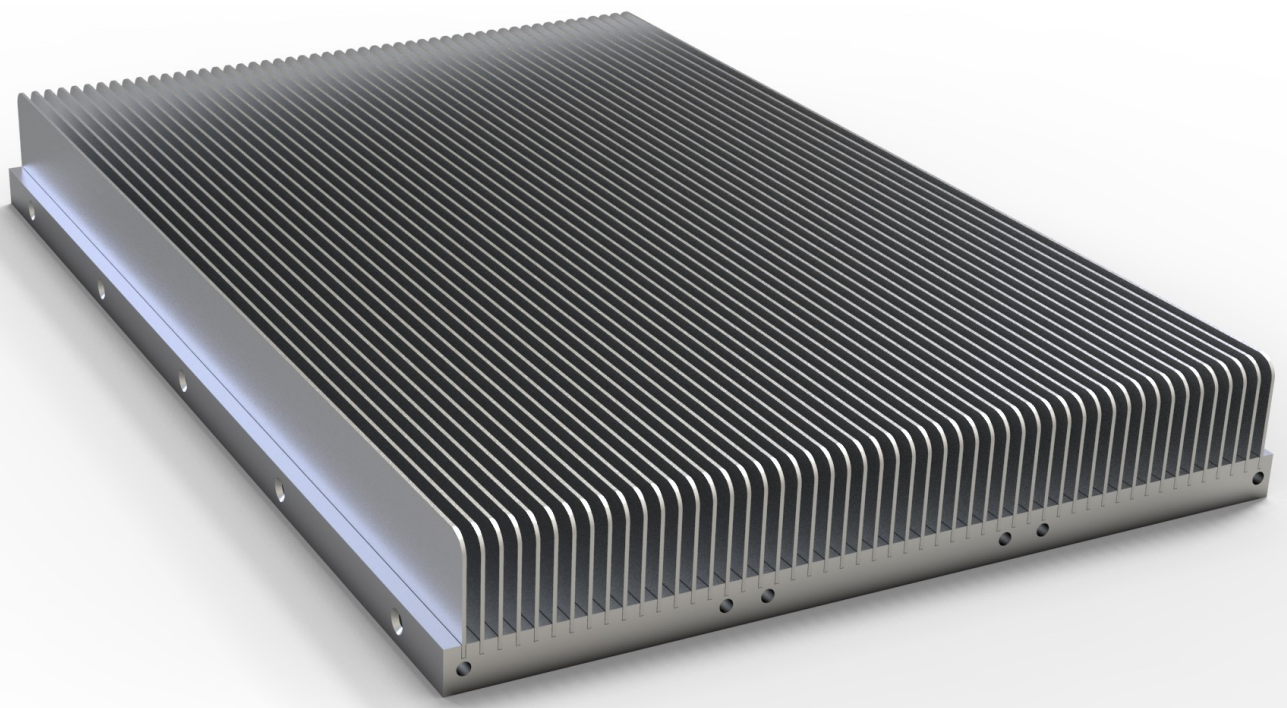

***Stacked Fin Heatsinks - 4***



***STACKED FIN HEATSINK FOR INVERTER***

***P***



***HOLLOW-FIN STACKED HEATSINK***

***P***



***HIGH CAPACITY COOLING SYSTEM***

***P***



***CUSTOMIZED STACKED FIN HEATSINK***

***P***

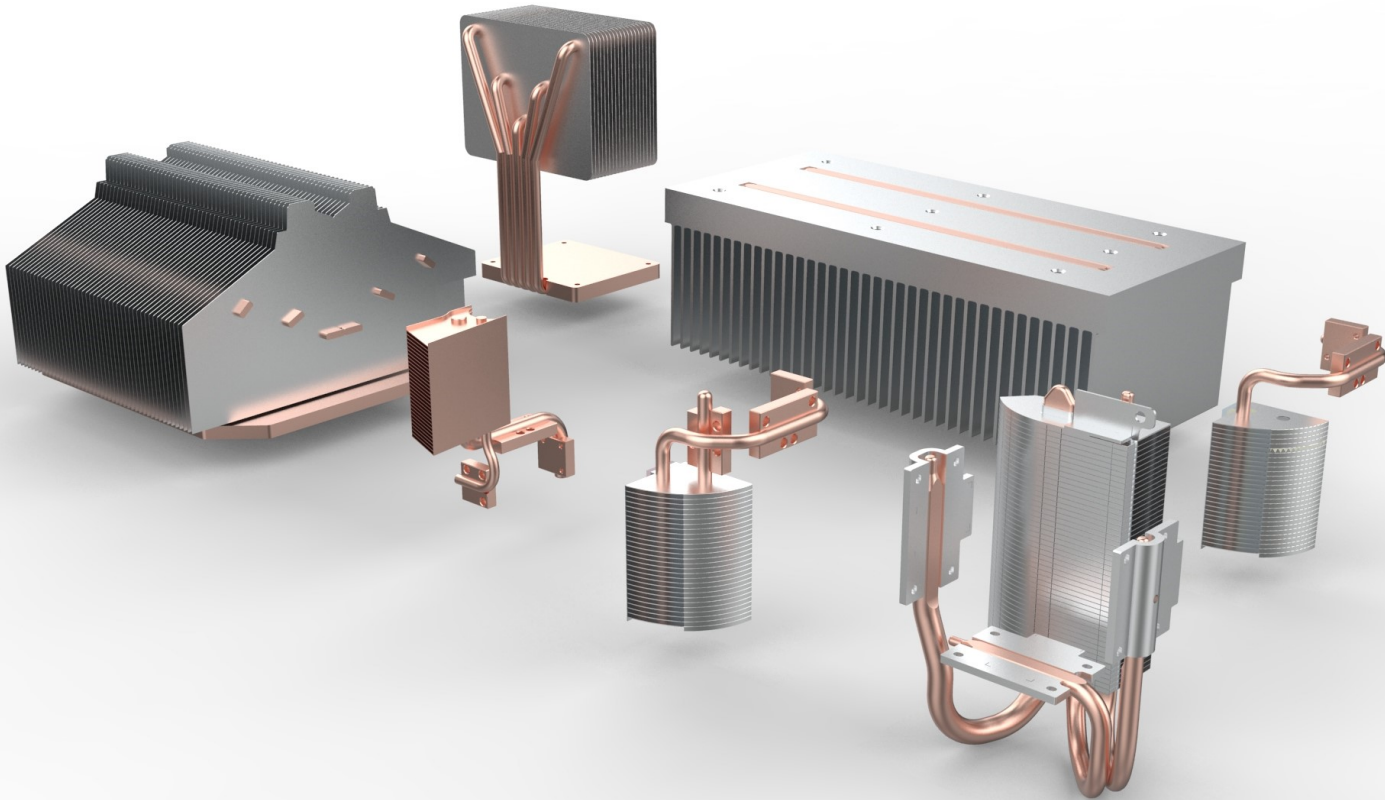

*Heat pipe Heatsinks - 5*



*HIGH PERFORMANCE HEAT PIPE HEATSINK*

*P*



*MINIATURE HEAT PIPE*

*P*



*VAPOR CHAMBER*

*P*



*CUSTOMIZED VAPOR CHAMBER*

*P*

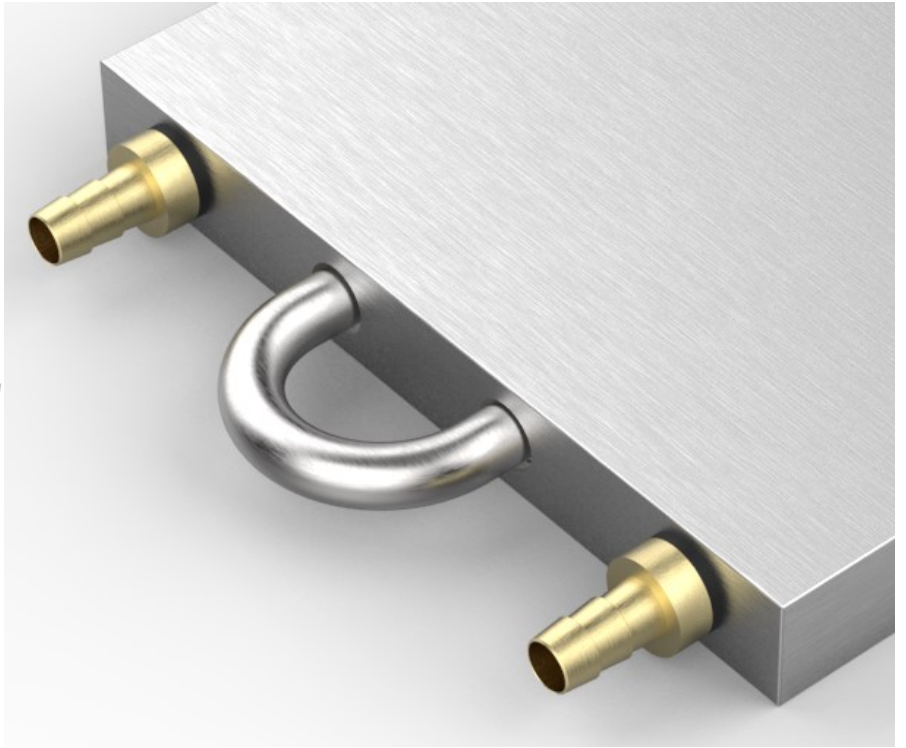
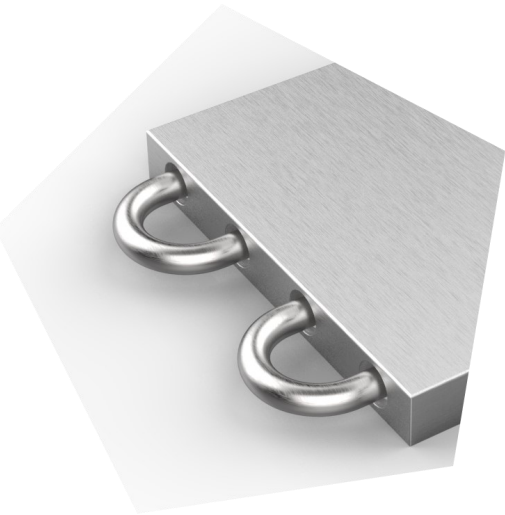

***Fluid Coolers - 6***



*HIGH PERFORMANCE EXTRUDE PROFILES FOR FLUID COOLING PLATE*

*P*



*FLUID COOLERS FOR IGBT MODULES*

*P*



*LOW COST COOLING PLATE*

*P*



*CUSTOMIZED FLUID COOLER PLATE S*

*P*



*FLUID COOLERS FOR ASSESSORIES*

*P*





## ***Accessories - 7***

**Mounting Accessories with Insulating bush**

**Clip mounting**

**Transistor insulation washers in Kapton**

**Led light for accessories**

**CNC OEM**

**Insulating spacers**

**Thermally conductive adhesive**



## Ordering Note

Your order needs to contain the following information

**RX612-050-A4**

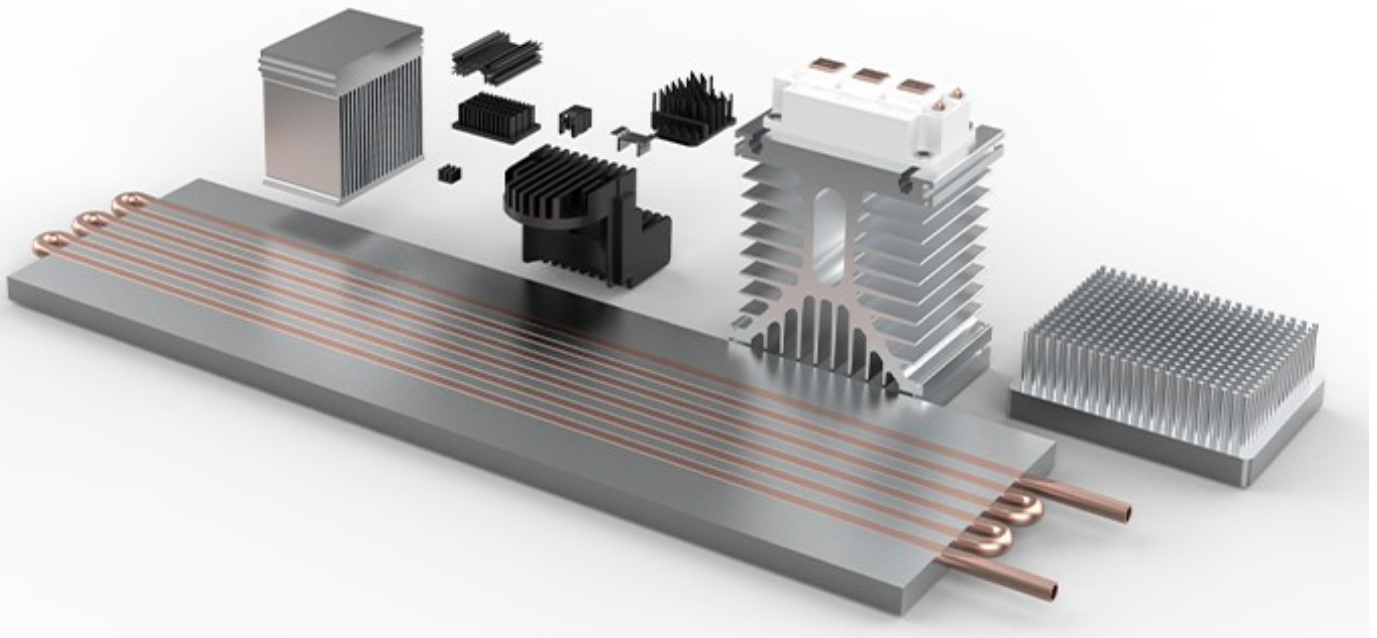

CODE	GENERAL FINISH
A1	Clear , No finish
A2	Gold Chromate Conversion
A3	Natural Anodize
A4	Black Anodize
A5	Clear Chromate Conversion
A6	Bronze Plated, Nickel Plated
A7	Green Anodize
A8	Red Anodize
A9	Blue Anodize
A10	Purple Anodize

### Important Note:

Extruded heatsink profiles apply to standards DIN EN 12020. Standards DIN EN755 will be used for the profiles with width exceed 300 mm, CNC Machining apply to standards DIN ISO 2768-M. The normal material of heatsinks is aluminum alloy AL6063-T5 (AlMgSi05 – F22 acc. to DIN 1748). We can make the heatsinks according to customers' drawing or sample, and ensure the appearance meet customers' requirements. Standard surface treatments are no finish (A1) and black anodize (A4). Please refer to the finish code table for different finish.

# Heatsink—Chart

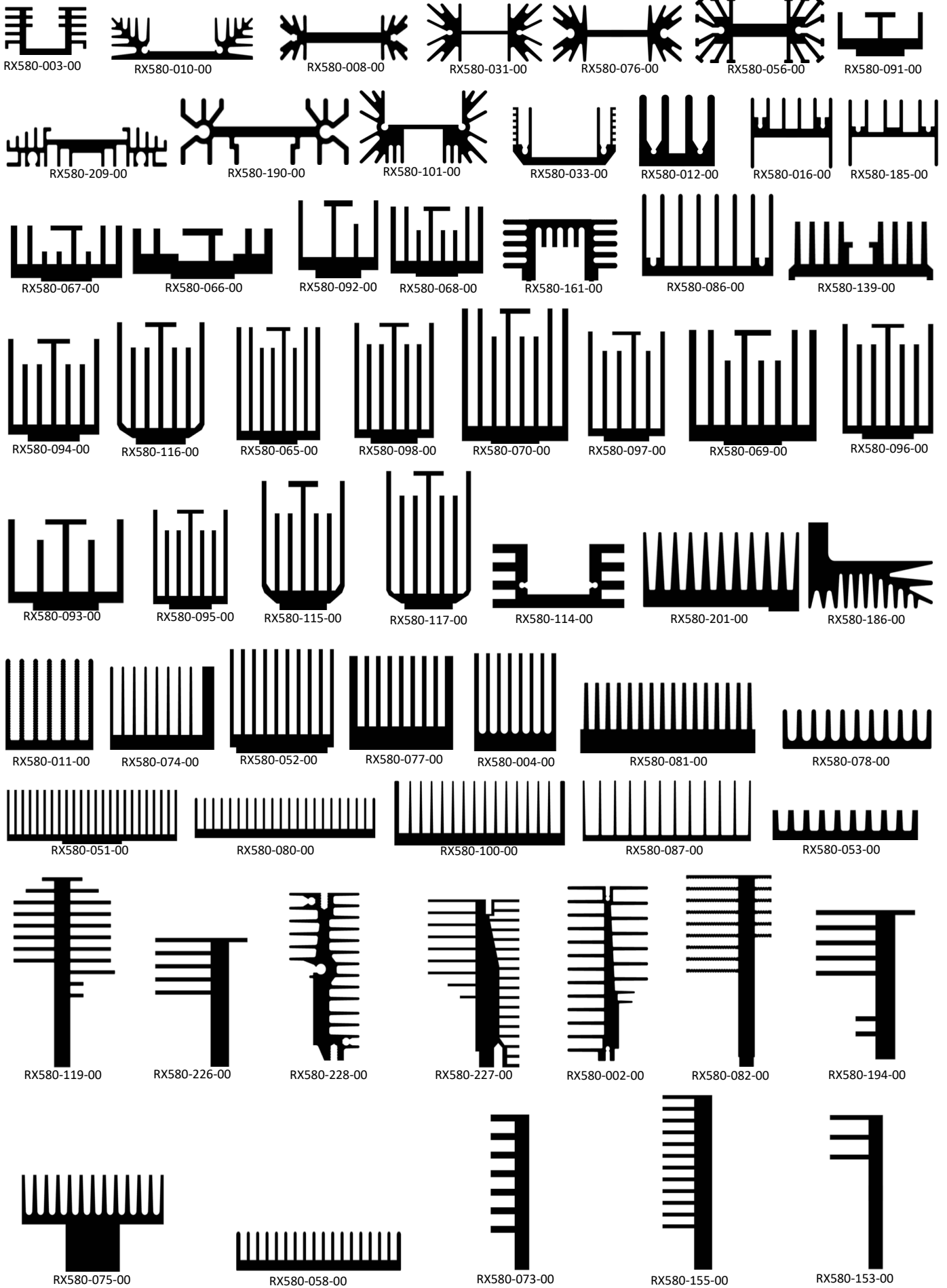

# Heatsink—Chart



RX580-055-00



RX580-042-00



RX580-024-00

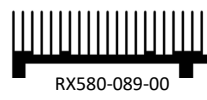

RX580-089-00



RX580-107-00



RX580-041-00



RX580-121-00



RX580-103-00



RX580-079-00



RX580-023-00



RX580-102-00



RX580-049-00



RX580-126-00

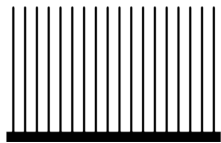

RX580-108-00

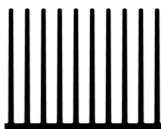

RX580-120-00



RX580-109-00

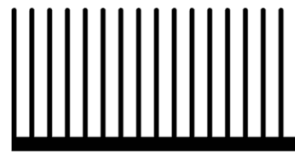

RX580-129-00

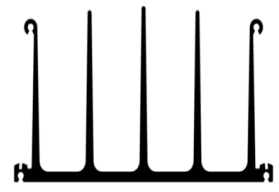

RX580-131-00



RX580-135-00



RX580-137-00



RX580-106-00



RX580-122-00



RX580-127-00



RX580-128-00



RX580-138-00



RX580-193-00



RX580-225-00



RX580-169-00



RX580-134-00



RX580-167-00

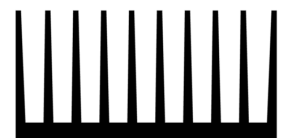

RX580-206-00



RX580-168-00

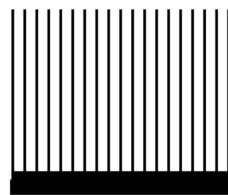

RX580-174-00



RX580-171-00



RX580-216-00

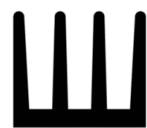

RX580-1820-00



RX580-173-00



RX580-166-00



RX580-140-00



RX580-143-00



RX580-159-00

# Heatsink-Chart



RX580-157-00



RX580-150-00



RX580-154-00



RX580-152-00



RX580-154-00



RX580-155-00



RX580-165-00



RX580-164-00

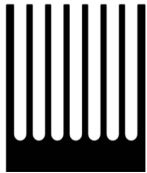

RX580-153-00



RX580-158-00

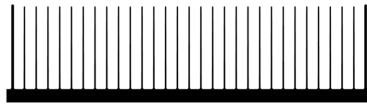

RX580-163-00



RX580-162-00

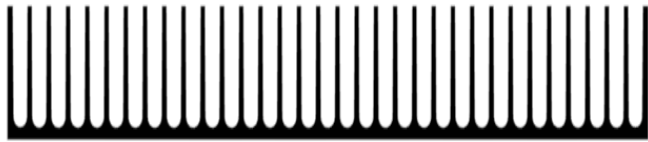

RX580-156-00

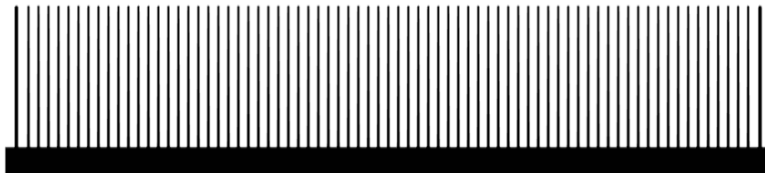

RX580-160-00

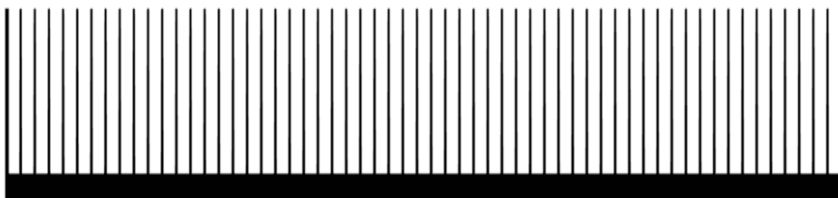

RX580-161-00

## EXTRUDED HEATSINKS WITH SOLDER PIN FOR PCB MOUNTING

RX580-003-A4

Material	AL6063-T5
Weight	0.39kg/meter

Other lengths and hole patterns on customer request.

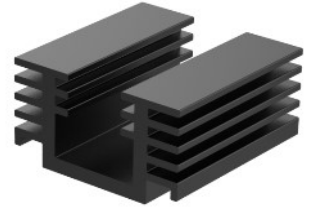
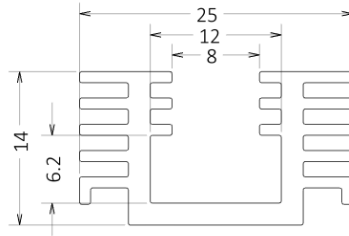
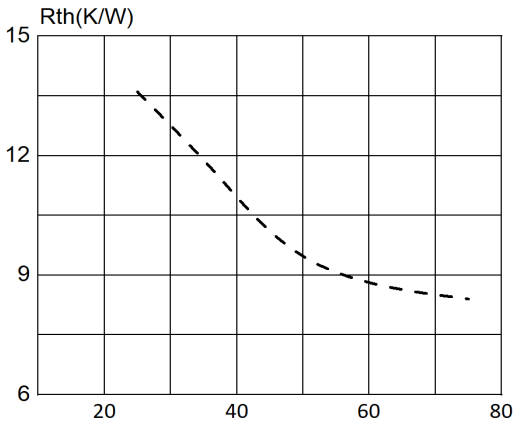

RX580-008-A4

Material	AL6063-T5
Weight	0.59kg/meter

Other lengths and hole patterns on customer request.

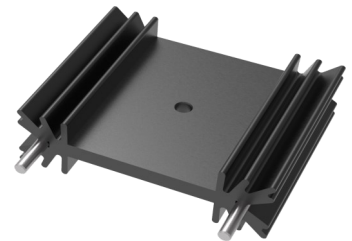
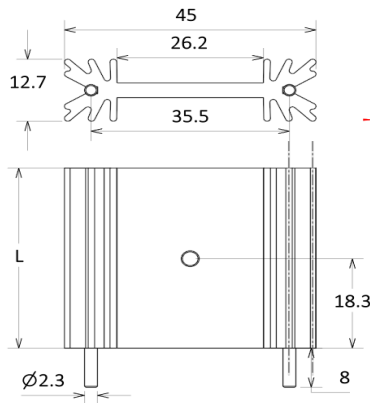
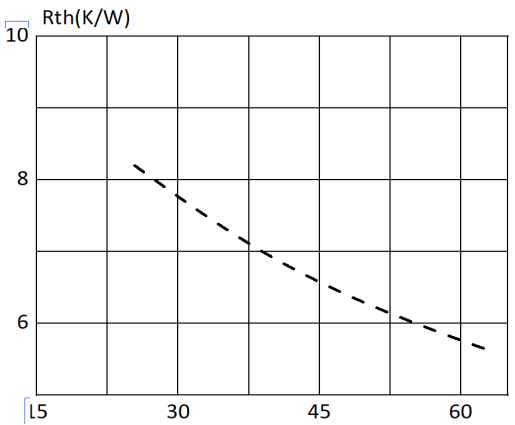

RX580-010-A4

Material	AL6063-T5
Weight	1.24kg/meter

Other lengths and hole patterns on customer request.

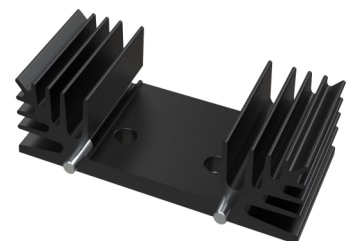
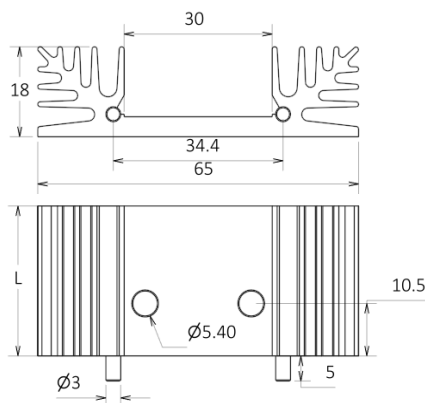
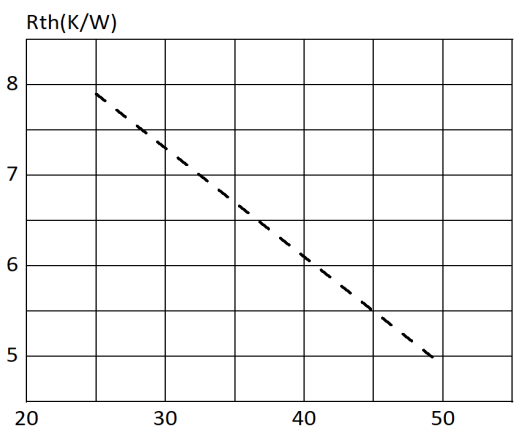

## EXTRUDED HEATSINKS WITH SOLDER PIN FOR PCB MOUNTING

### RX580-012-A4

Material	AL6063-T5
Weight	0.39kg/meter

Other lengths and hole patterns on customer request.

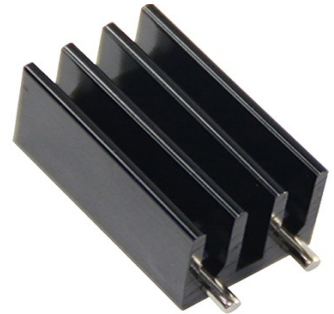
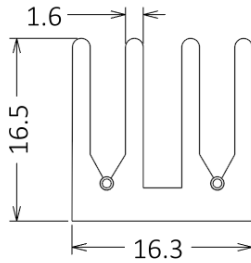
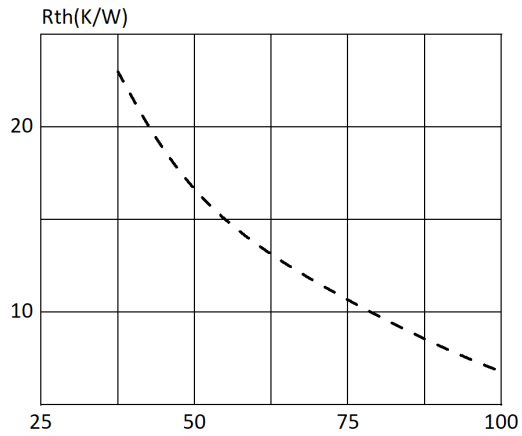

### RX580-016-A4

Material	AL6063-T5
Weight	0.32kg/meter

Other lengths and hole patterns on customer request.

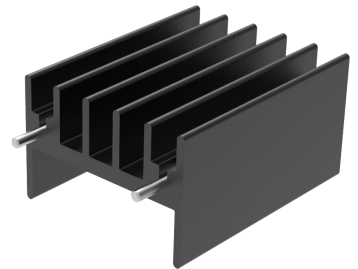
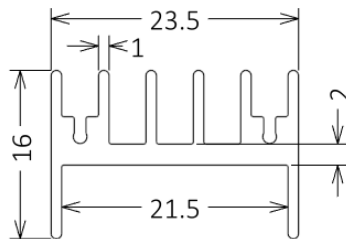
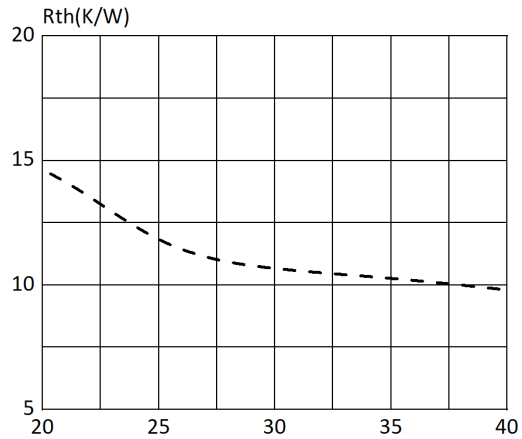

### RX580-031-A4

Material	AL6063-T5
Weight	0.94kg/meter

Other lengths and hole patterns on customer request.

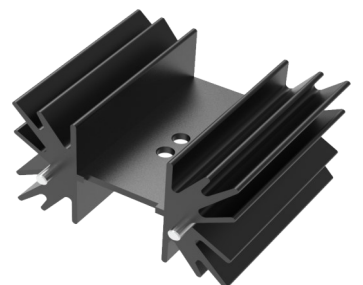
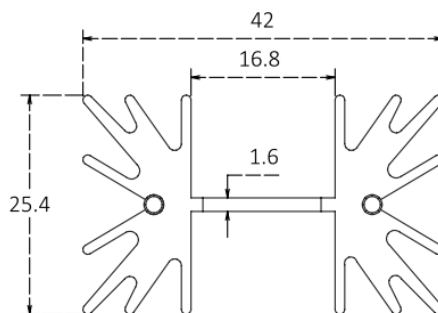
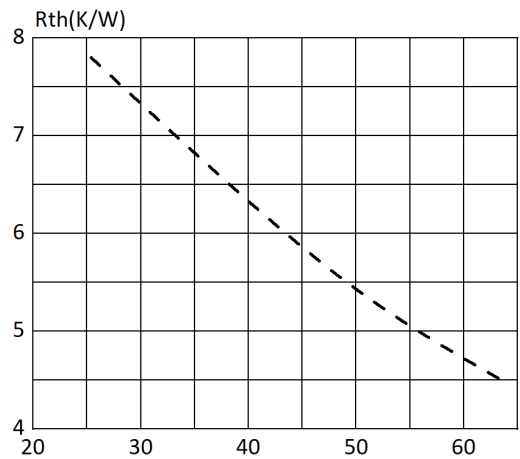



## EXTRUDED HEATSINKS WITH SOLDER PIN FOR PCB MOUNTING

### RX580-033-A4

Material	AL6063-T5
Weight	0.78kg/meter

Other lengths and hole patterns on customer request.

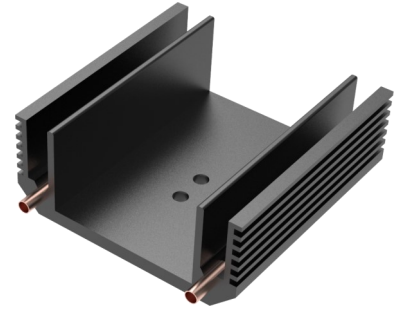
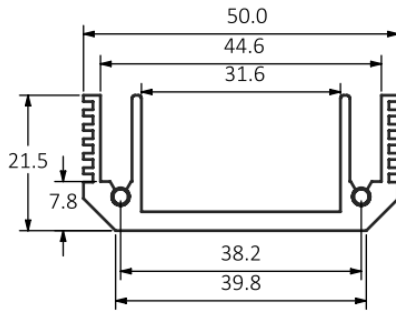
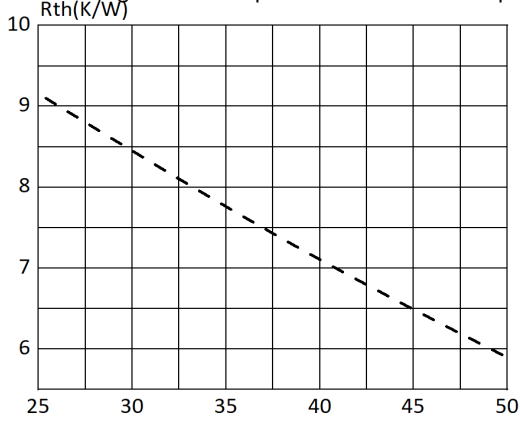

### RX580-056-A4

Material	AL6063-T5
Weight	1.32kg/meter

Other lengths and hole patterns on customer request.

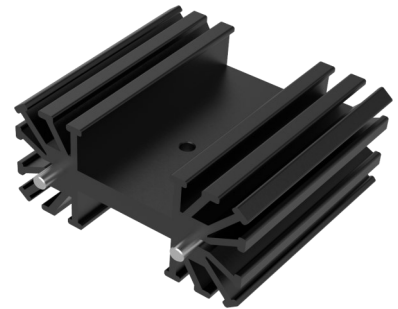
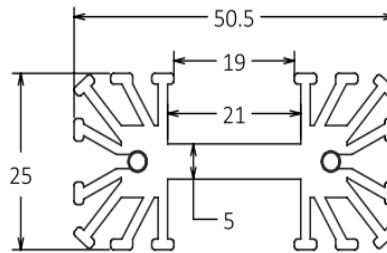
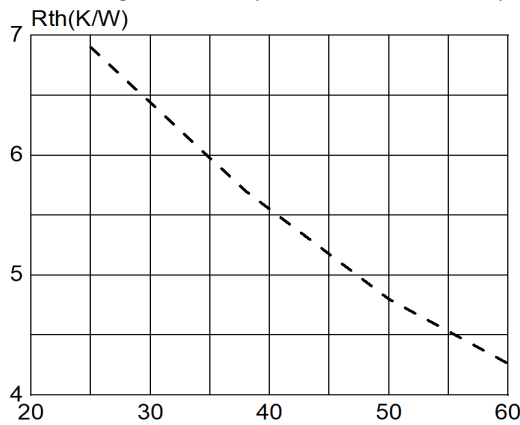

### RX580-065-A4

Material	AL6063-T5
Weight	0.43kg/meter

Other lengths and hole patterns on customer request.

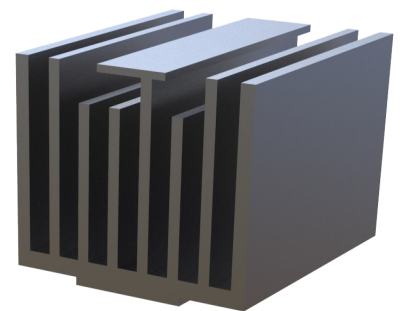
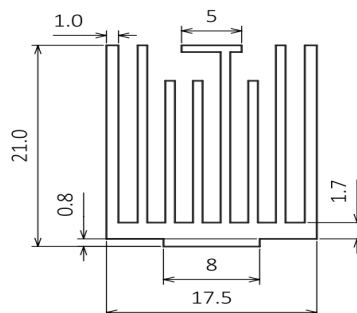
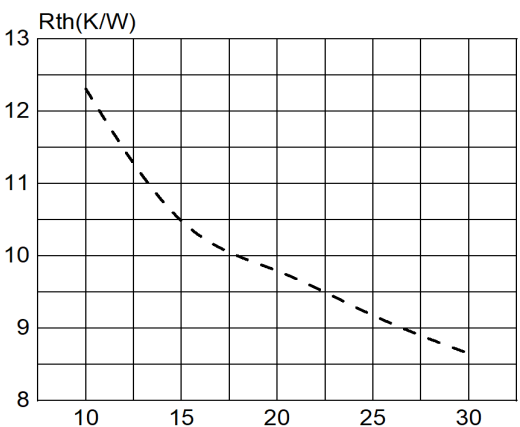

## EXTRUDED HEATSINKS WITH SOLDER PIN FOR PCB MOUNTING

RX580-066-A1

Material	AL6063-T5
Weight	1.32 kg/meter

Other lengths and hole patterns on customer request.

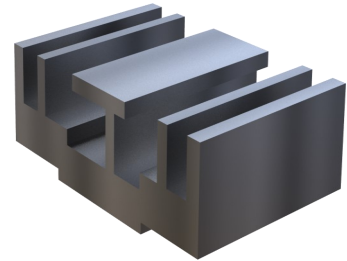
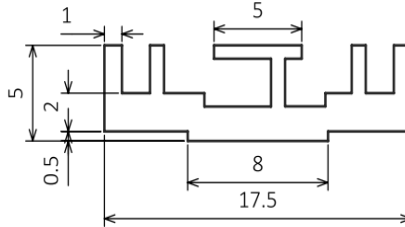
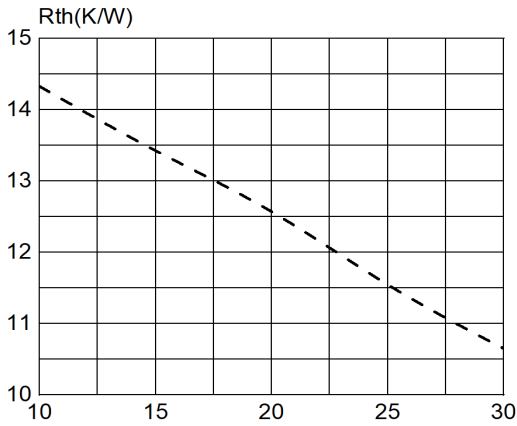

RX580-067-A1

Material	AL6063-T5
Weight	0.2 kg/meter

Other lengths and hole patterns on customer request.

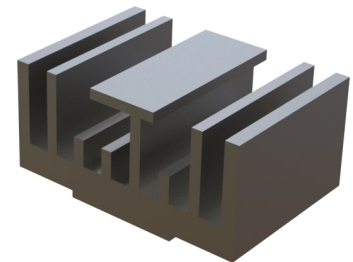
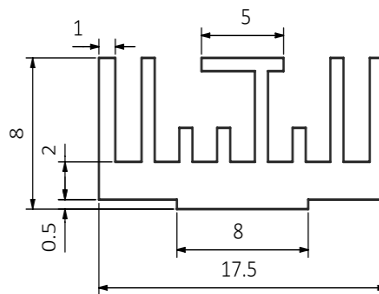
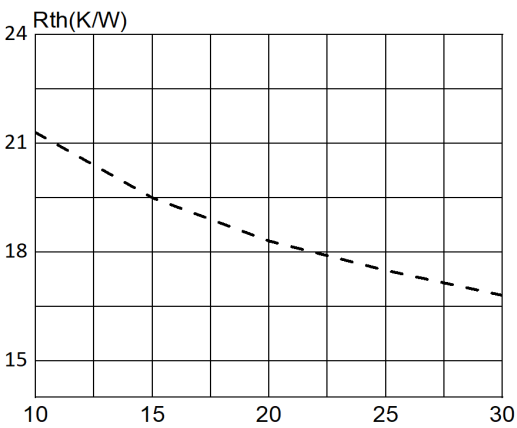

RX580-068-A1

Material	AL6063-T5
Weight	0.25 kg/meter

Other lengths and hole patterns on customer request.

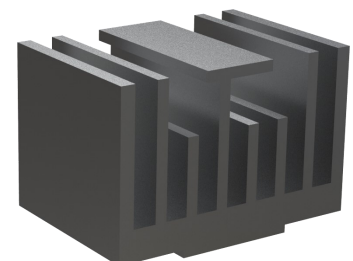
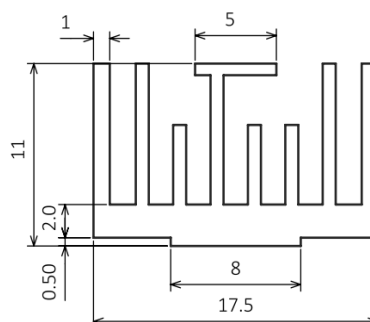
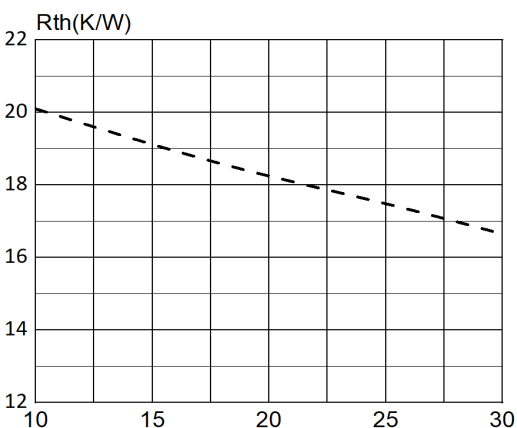

## EXTRUDED HEATSINKS WITH SOLDER PIN FOR PCB MOUNTING

### RX580-069-A1

Material	AL6063-T5
Weight	0.31 kg/meter

Other lengths and hole patterns on customer request.

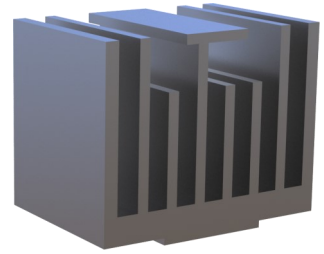
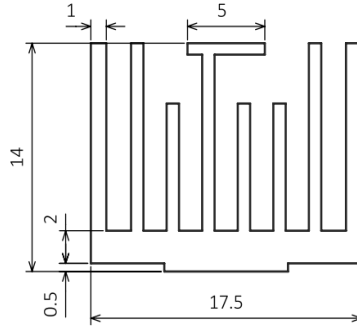
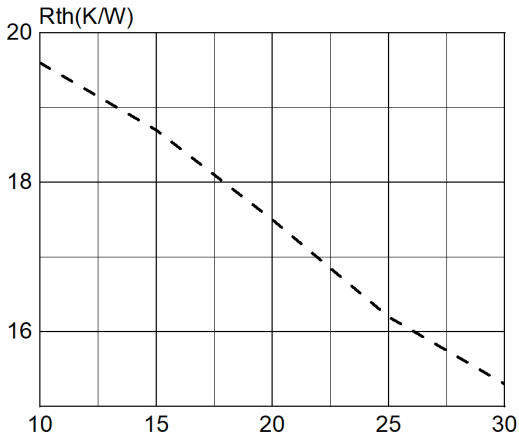

### RX580-070-A1

Material	AL6063-T5
Weight	0.38 kg/meter

Other lengths and hole patterns on customer request.

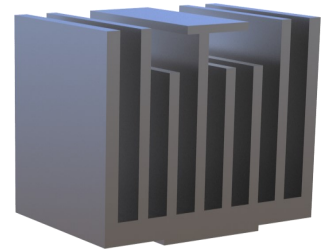
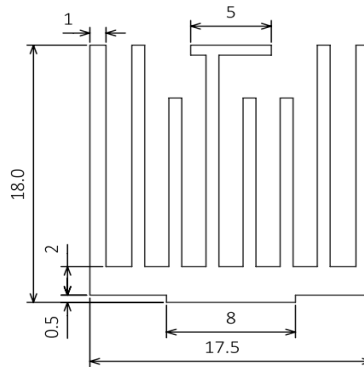
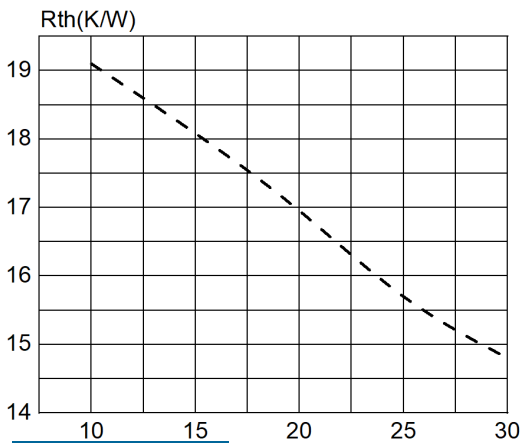

### RX580-086-A1

Material	AL6063-T5
Weight	0.73 kg/meter

Other lengths and hole patterns on customer request.

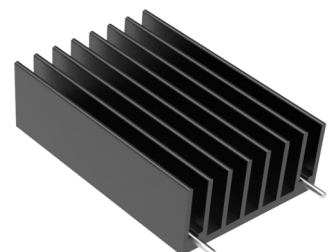
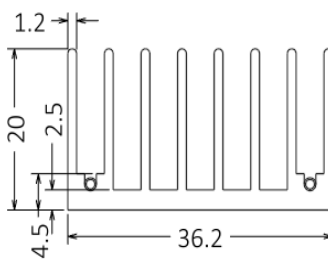
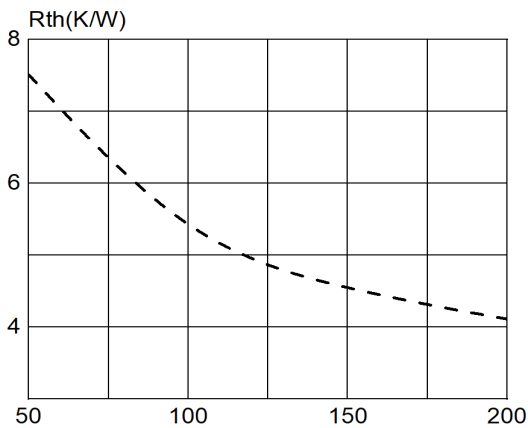

## EXTRUDED HEATSINKS WITH SOLDER PIN FOR PCB MOUNTING

### RX580-101-A1

Material	AL6063-T5
Weight	0.93 kg/meter

Other lengths and hole patterns on customer request.

Rth(K/W)

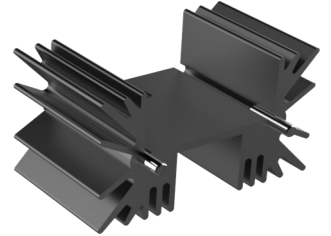
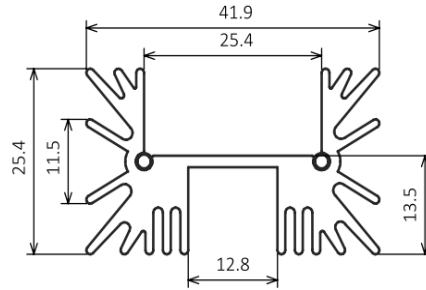
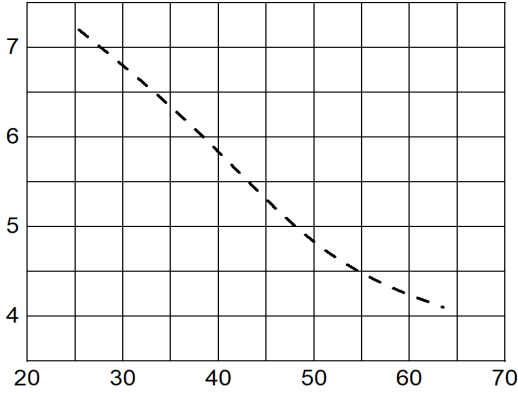

### RX580-114-A4

Material	AL6063-T5
Weight	0.58 kg/meter

Other lengths and hole patterns on customer request.

Rth(K/W)

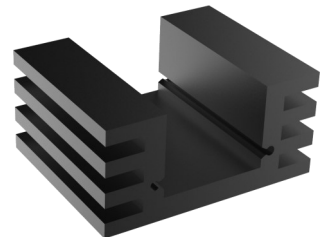
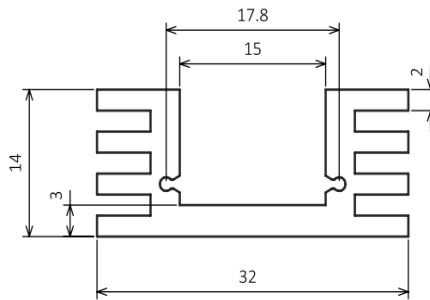
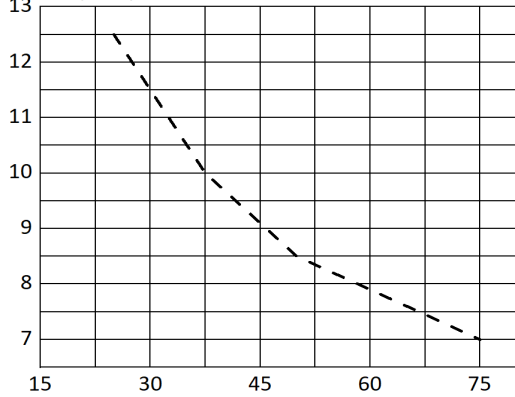

### RX580-115-A6

Material	AL6063-T5
Weight	0.24 kg/meter

Other lengths and hole patterns on customer request.

Rth(K/W)

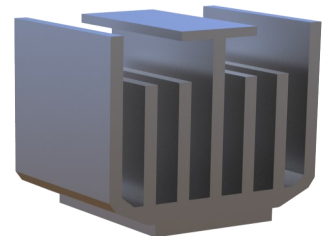
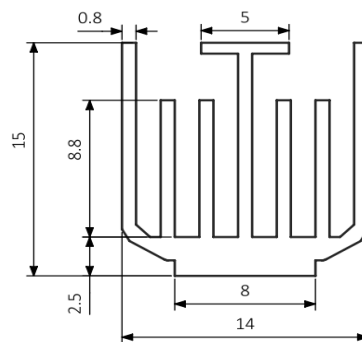
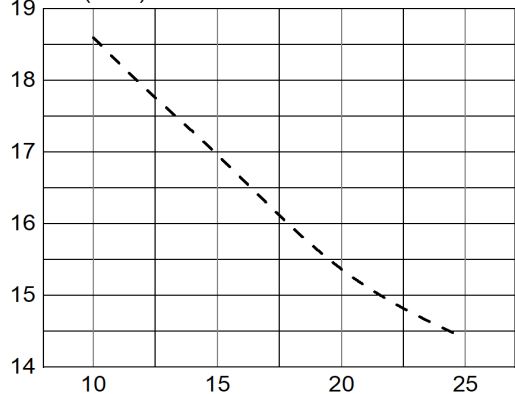

## EXTRUDED HEATSINKS WITH SOLDER PIN FOR PCB MOUNTING

### RX580-116-A6

Material	AL6063-T5
Weight	0.29 kg/meter

Other lengths and hole patterns on customer request.

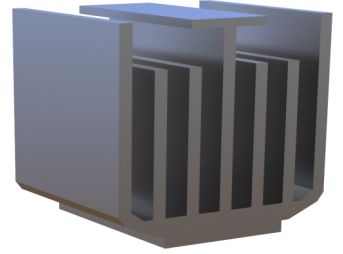
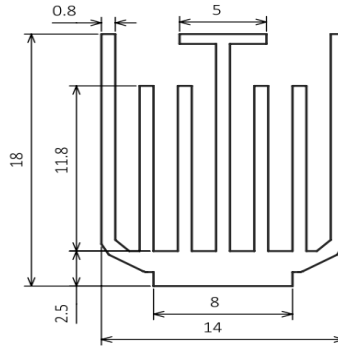
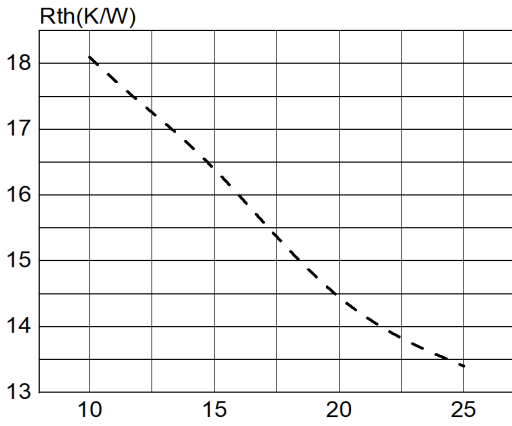

### RX580-139-A4

Material	AL6063-T5
Weight	0.96 kg/meter

Other lengths and hole patterns on customer request.

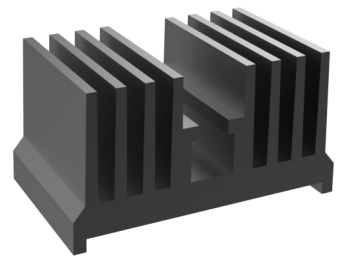
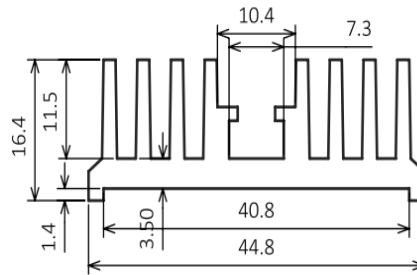
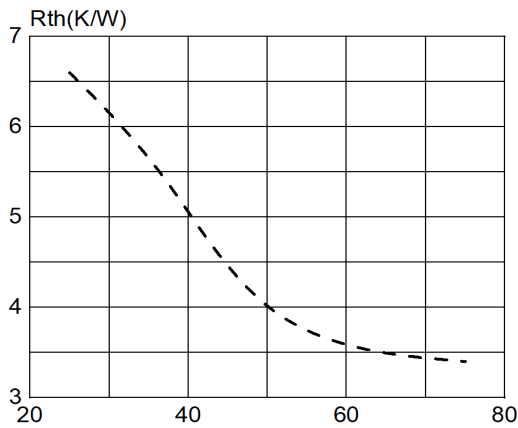

### RX580-161-A6

Material	AL6063-T5
Weight	0.42 kg/meter

Other lengths and hole patterns on customer request.

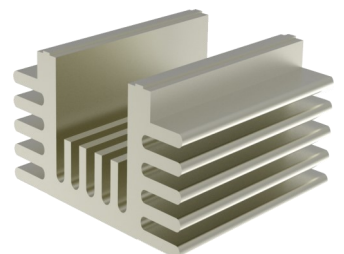
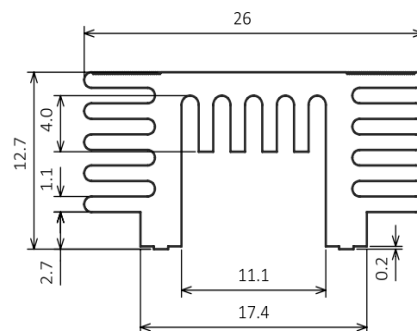
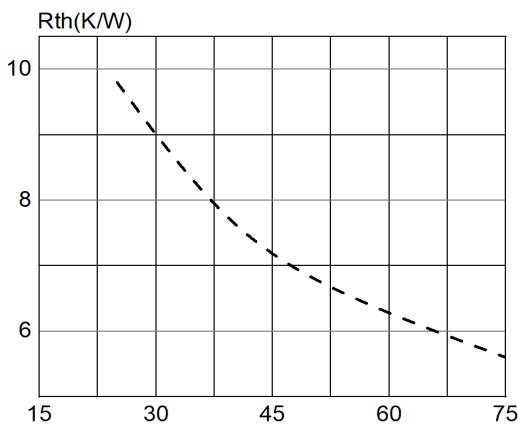

## EXTRUDED HEATSINKS WITH SOLDER PIN FOR PCB MOUNTING

### RX580-185-A6

Material	AL6063-T5
Weight	0.26 kg/meter

Other lengths and hole patterns on customer request.

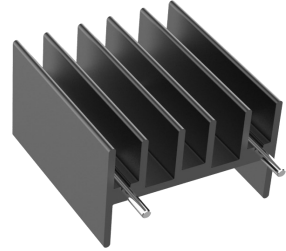
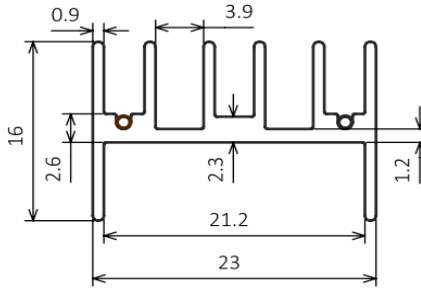
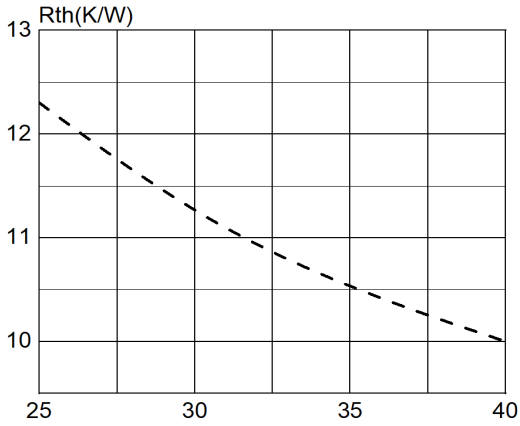

### RX580-186-A4

Material	AL6063-T5
Weight	1.64 kg/meter

Other lengths and hole patterns on customer request.

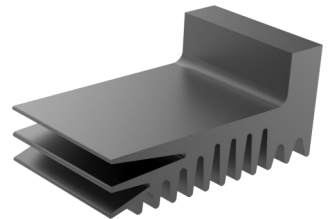
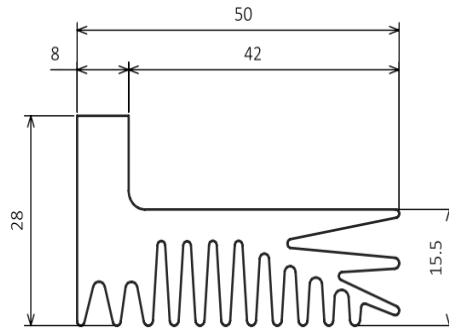
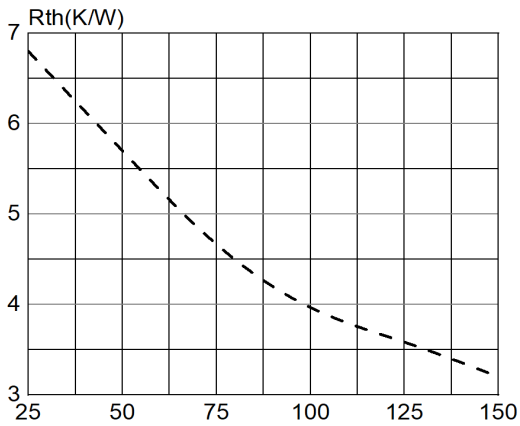

### RX580-190-A4

Material	AL6063-T5
Weight	0.35 kg/meter

Other lengths and hole patterns on customer request.

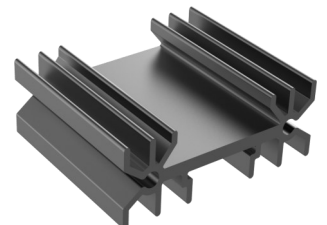
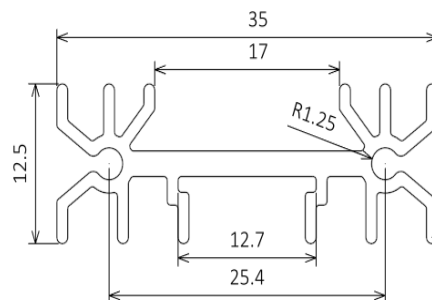
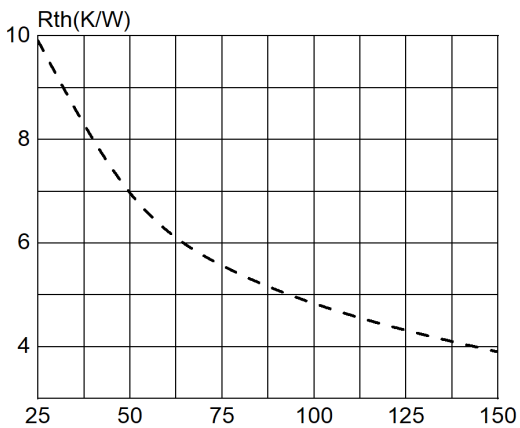

## EXTRUDED HEATSINKS WITH SOLDER PIN FOR PCB MOUNTING

### RX580-201-A4

Material	AL6063-T5
Weight	0.53 kg/meter

Other lengths and hole patterns on customer request.

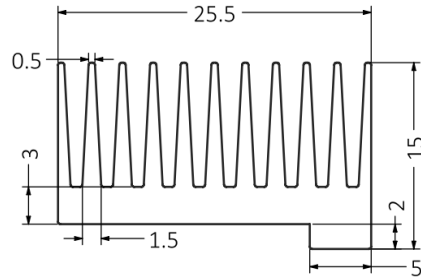
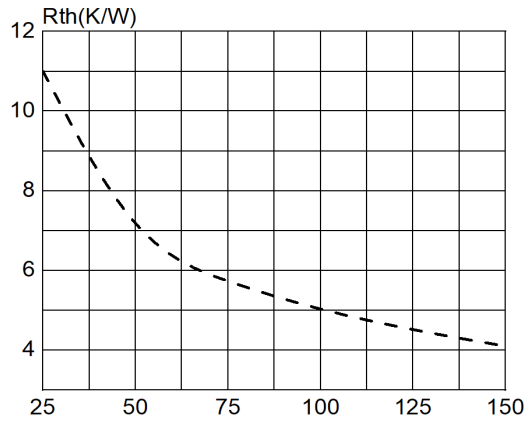

### RX580-209-A4

Material	AL6063-T5
Weight	0.32 kg/meter

Other lengths and hole patterns on customer request.

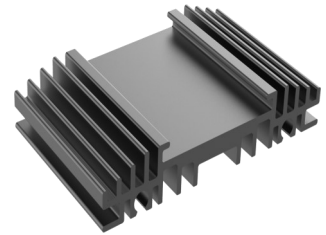
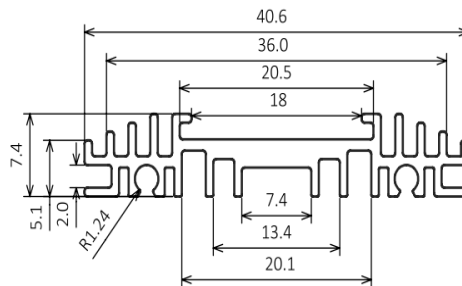
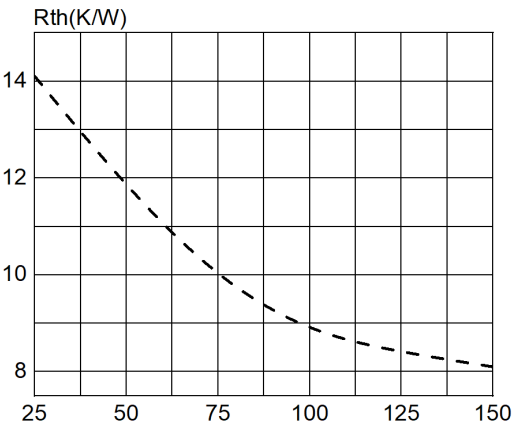

### RX580-002-A4

Material	AL6063-T5
Weight	3.67 kg/meter

Other lengths and hole patterns on customer request.

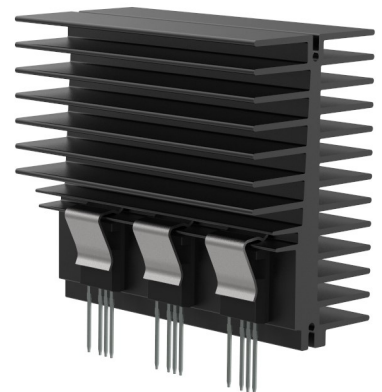
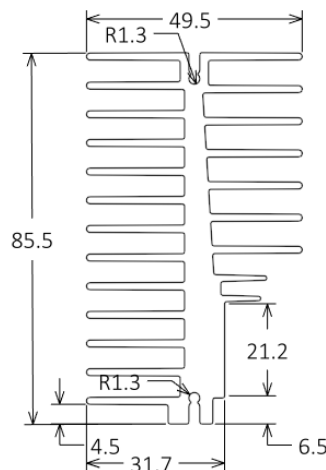
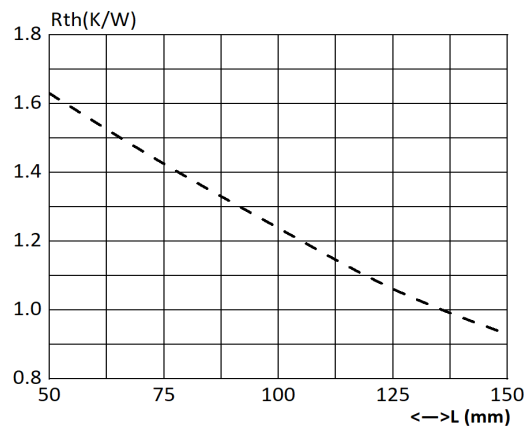

## EXTRUDED HEATSINKS WITH SOLDER PIN FOR PCB MOUNTING

### RX580-119-A4

Material	AL6063-T5
Weight	2.92 kg/meter

Other lengths and hole patterns on customer request.

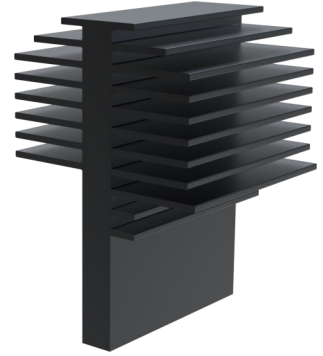
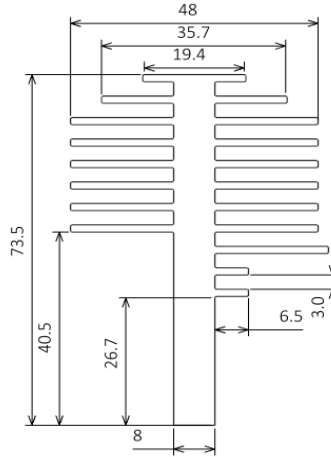
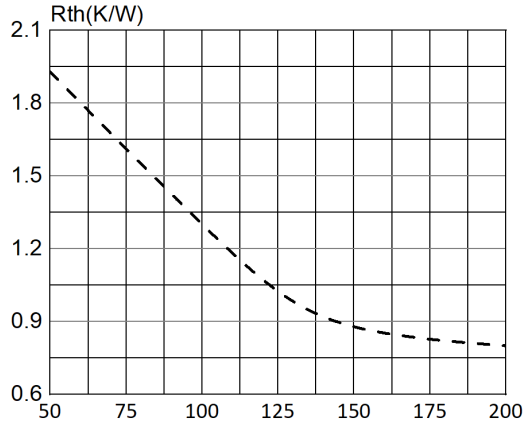

### RX580-153-A4

Material	AL6063-T5
Weight	0.37 kg/meter

Other lengths and hole patterns on customer request.

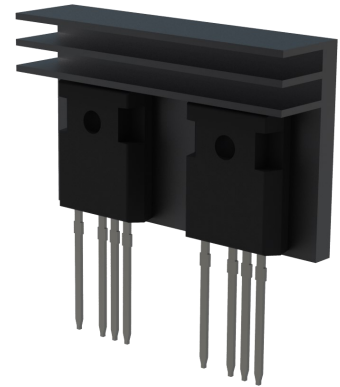
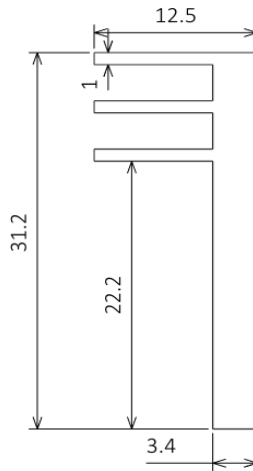
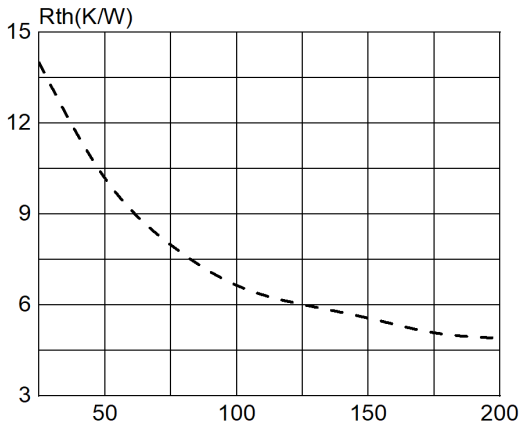

### RX580-155-A4

Material	AL6063-T5
Weight	2.2 kg/meter

Other lengths and hole patterns on customer request.

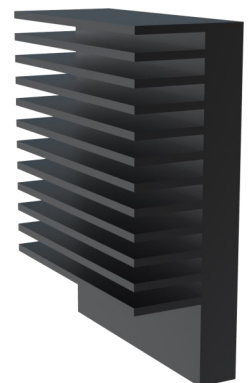
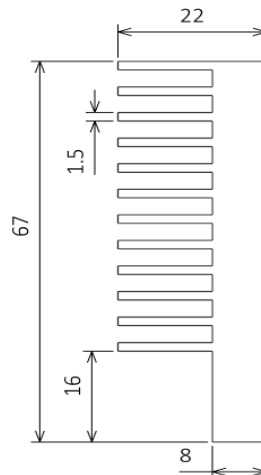
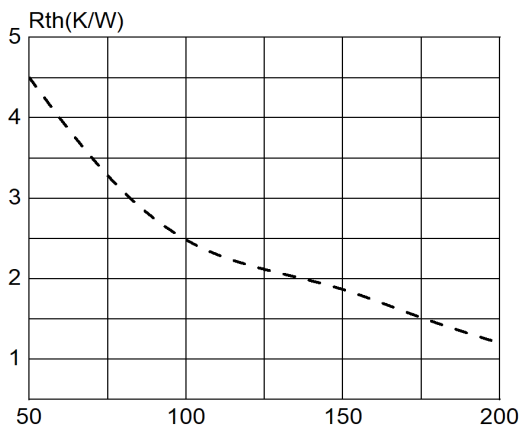



## EXTRUDED HEATSINKS WITH SOLDER PIN FOR PCB MOUNTING

RX580-194-A4

Material	AL6063-T5
Weight	0.66 kg/meter

Other lengths and hole patterns on customer request.

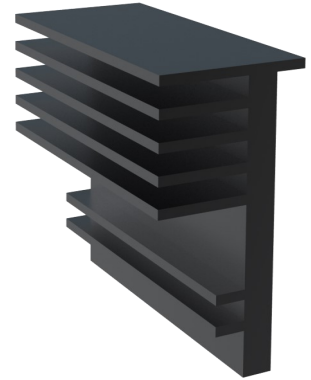
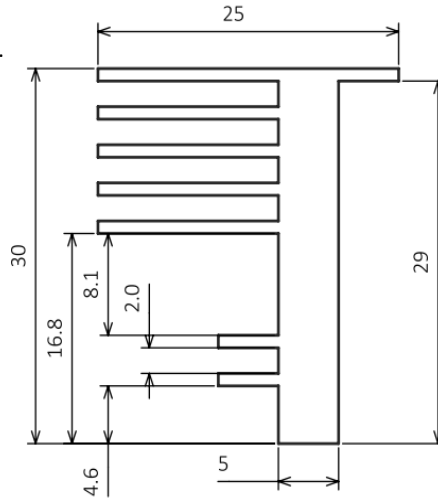
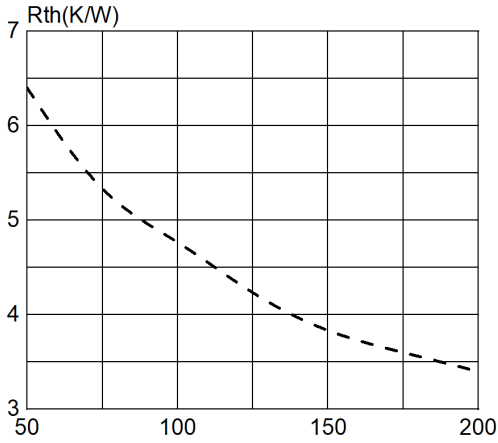

RX580-226-A4

Material	AL6063-T5
Weight	0.63 kg/meter

Other lengths and hole patterns on customer request.

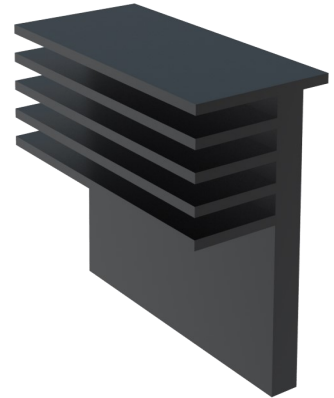
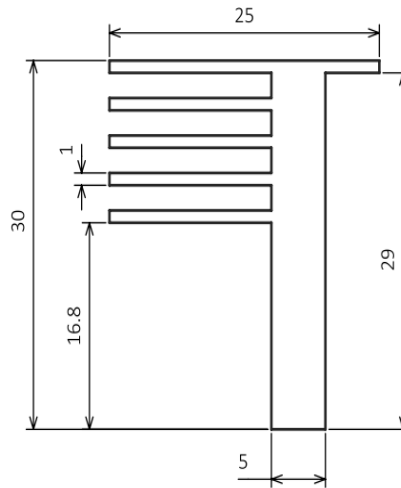
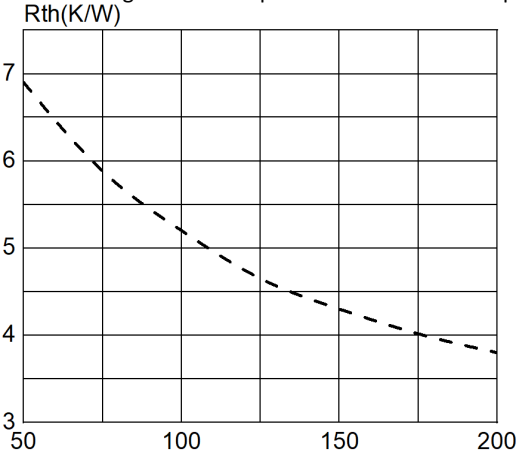

RX580-073-A4

Material	AL6063-T5
Weight	0.49 kg/meter

Other lengths and hole patterns on customer request.

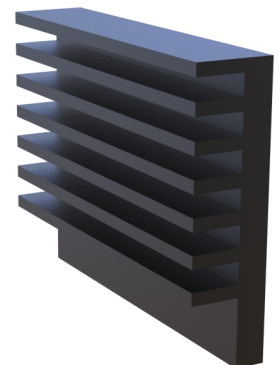
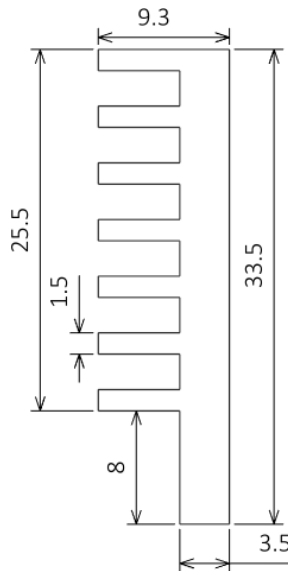
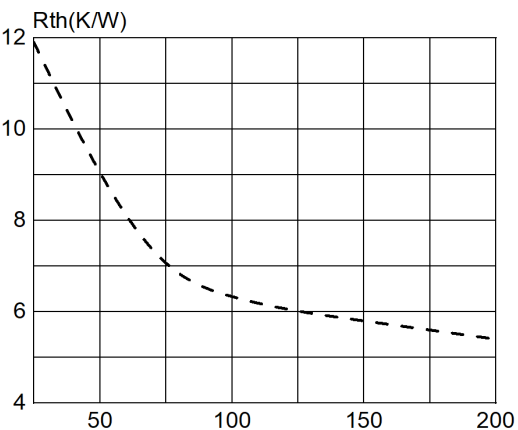

## EXTRUDED HEATSINKS WITH SOLDER PIN FOR PCB MOUNTING

RX580-228-A4

Material	AL6063-T5
Weight	1.7 kg/meter

Other lengths and hole patterns on customer request.

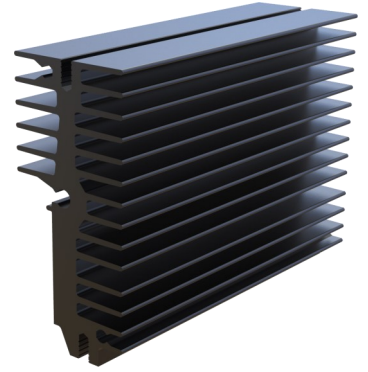
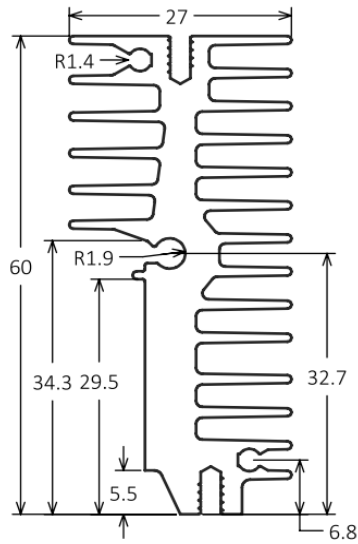
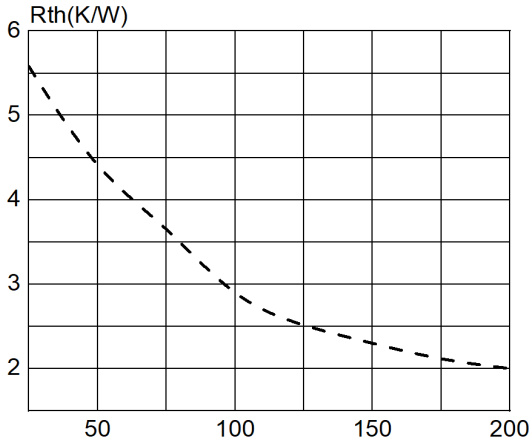

RX580-227-A4

Material	AL6063-T5
Weight	4.07 kg/meter

Other lengths and hole patterns on customer request.

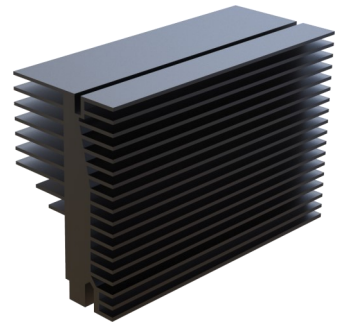
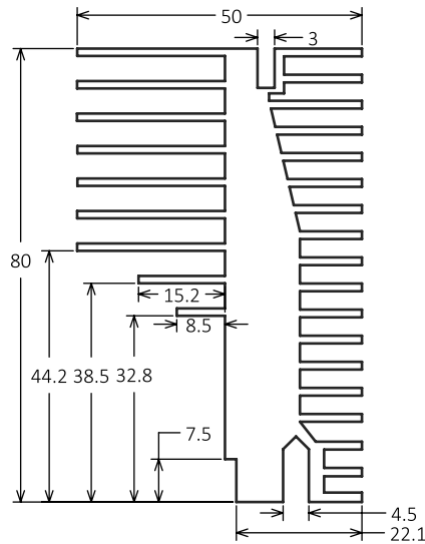
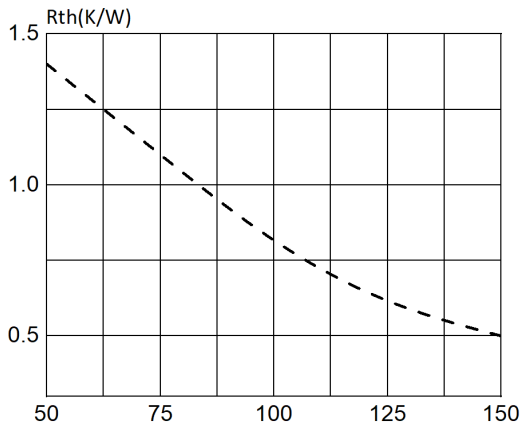

# STANDARD EXTRUDED HEATSINK FOR ALUMINUM

## RX580-182-00

Material	AL6063-T5
Weight	0.22 kg/meter

Other lengths and hole patterns on customer request.

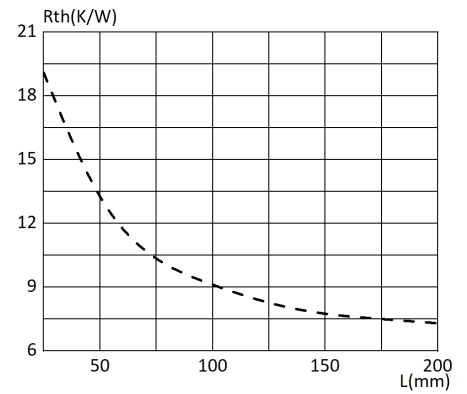
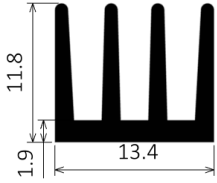

## RX580-137-00

Material	AL6063-T5
Weight	0.16 kg/meter

Other lengths and hole patterns on customer request.

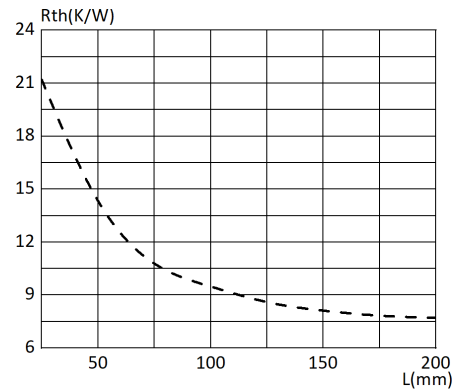

## RX580-052-00

Material	AL6063-T5
Weight	0.46 kg/meter

Other lengths and hole patterns on customer request.

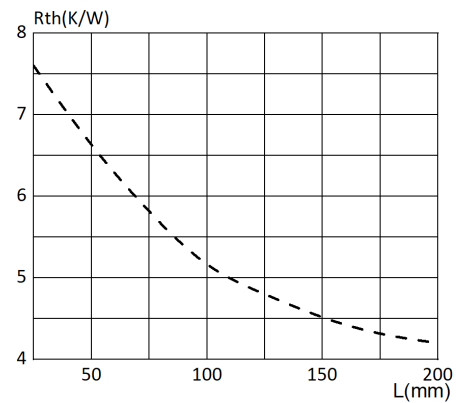
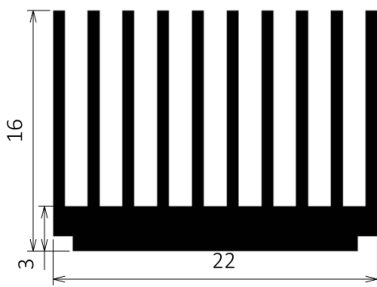

## RX580-120-00

Material	AL6063-T5
Weight	0.6 kg/meter

Other lengths and hole patterns on customer request.

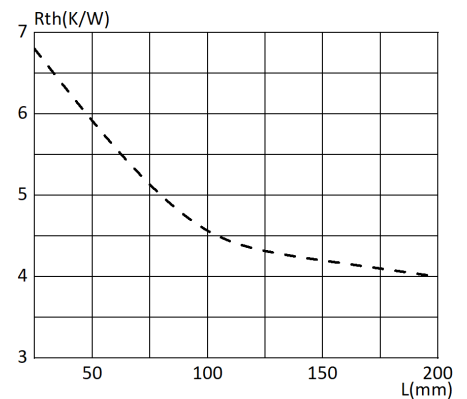
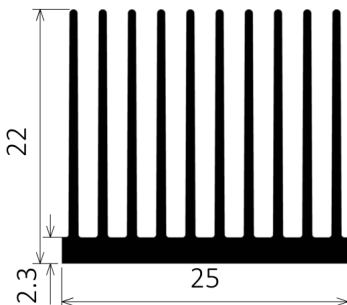

## STANDARD EXTRUDED HEATSINK FOR ALUMINUM

RX580-122-00

Material	AL6063-T5
Weight	0.77 kg/meter

Other lengths and hole patterns on customer request.

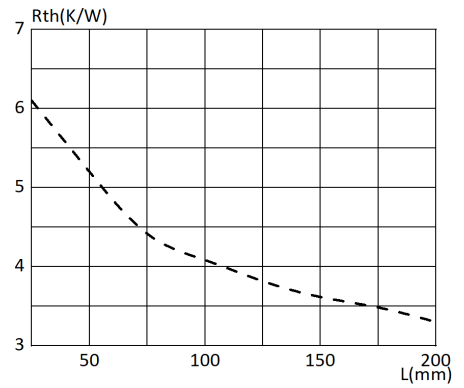
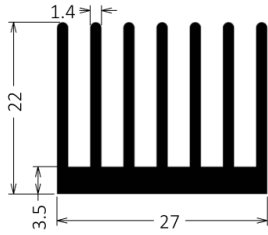

RX580-107-00

Material	AL6063-T5
Weight	0.55 kg/meter

Other lengths and hole patterns on customer request.

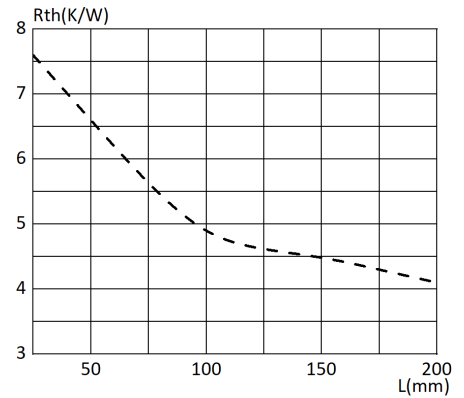
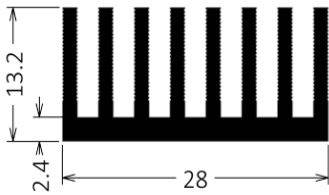

RX580-011-00

Material	AL6063-T5
Weight	0.76 kg/meter

Other lengths and hole patterns on customer request.

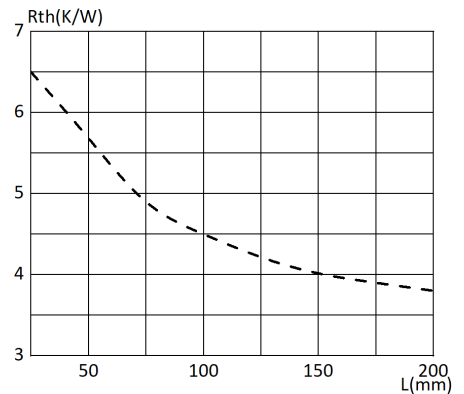
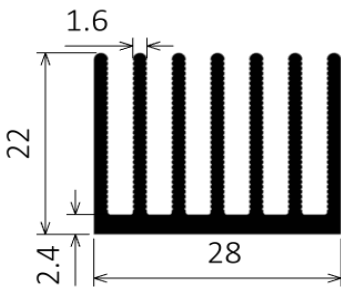

RX580-140-00

Material	AL6063-T5
Weight	0.69 kg/meter

Other lengths and hole patterns on customer request.

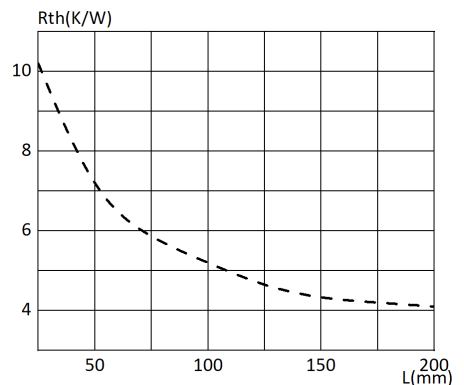
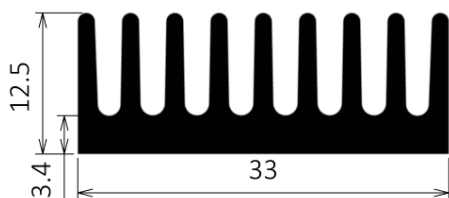

## STANDARD EXTRUDED HEATSINK FOR ALUMINUM

RX580-166-00

Material	AL6063-T5
Weight	0.34 kg/meter

Other lengths and hole patterns on customer request.

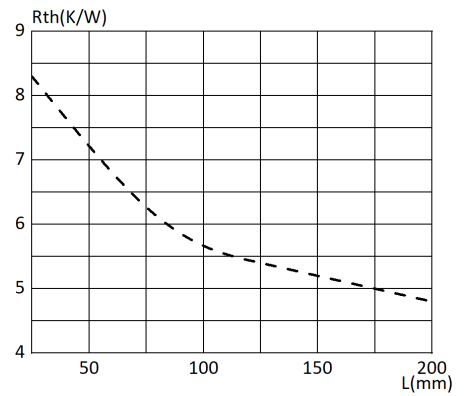
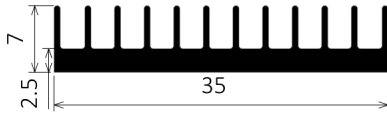

RX580-004-00

Material	AL6063-T5
Weight	2.5 kg/meter

Other lengths and hole patterns on customer request.

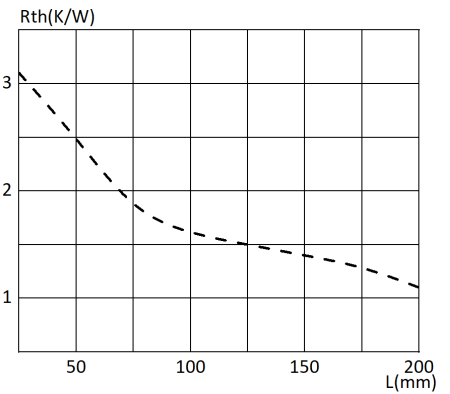
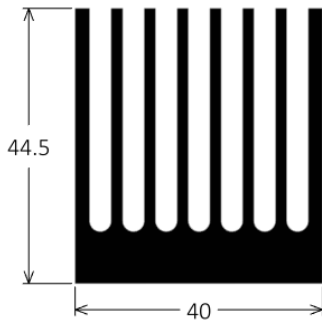

RX580-106-00

Material	AL6063-T5
Weight	0.47 kg/meter

Other lengths and hole patterns on customer request.

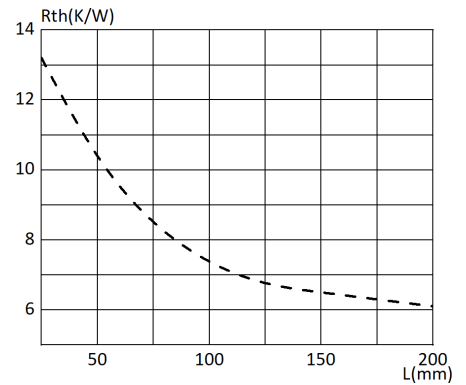
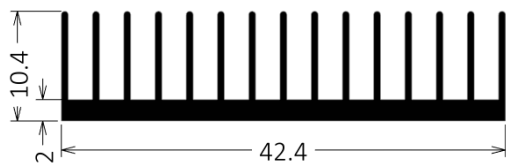

RX580-169-00

Material	AL6063-T5
Weight	0.58 kg/meter

Other lengths and hole patterns on customer request.

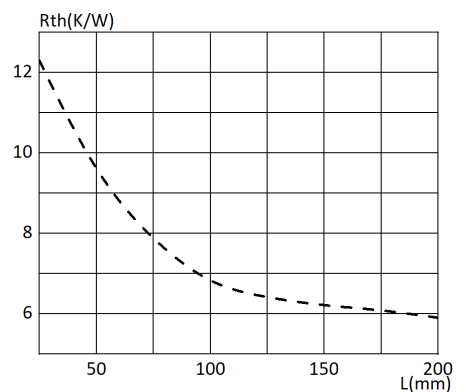
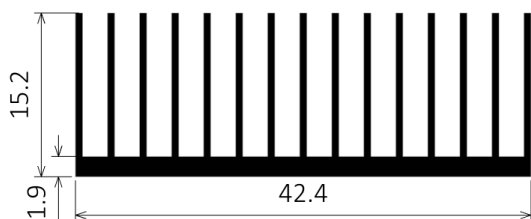

## STANDARD EXTRUDED HEATSINK FOR ALUMINUM

### RX580-168-00

Material	AL6063-T5
Weight	1.18 kg/meter

Other lengths and hole patterns on customer request.

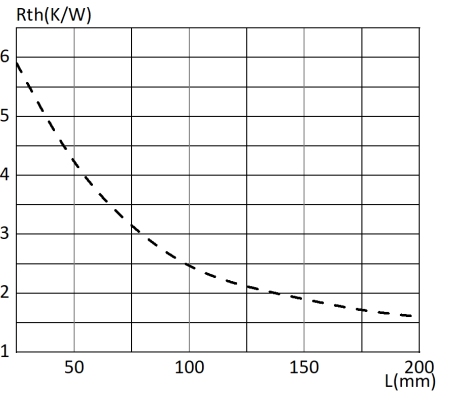
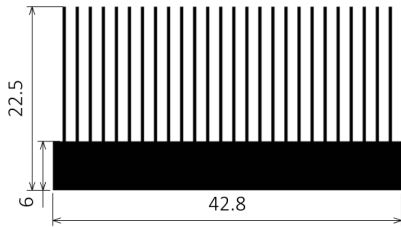

### RX580-078-00

Material	AL6063-T5
Weight	0.65 kg/meter

Other lengths and hole patterns on customer request.

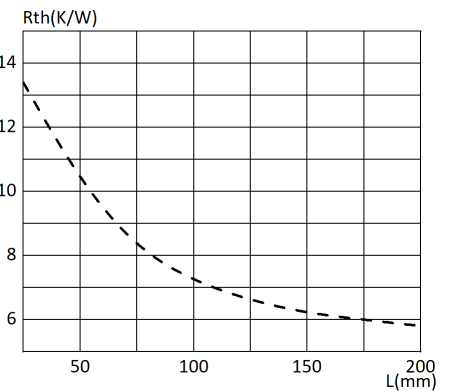
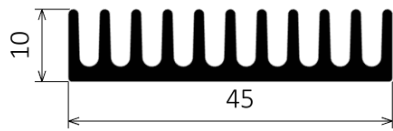

### RX580-077-00

Material	AL6063-T5
Weight	2.5 kg/meter

Other lengths and hole patterns on customer request.

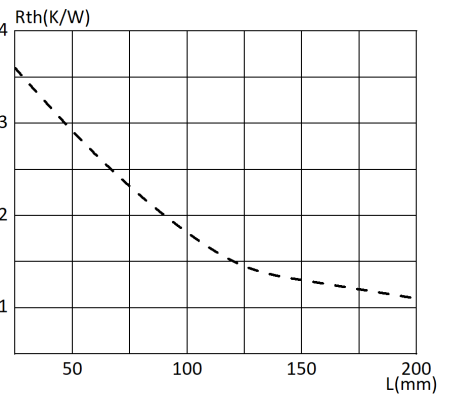
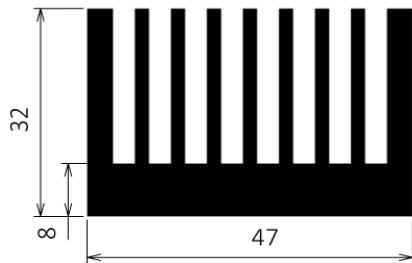

### RX580-081-00

Material	AL6063-T5
Weight	1.53 kg/meter

Other lengths and hole patterns on customer request.

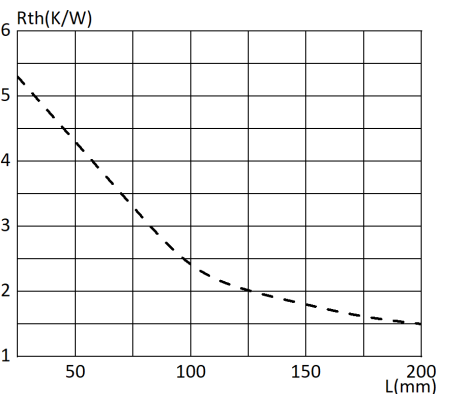
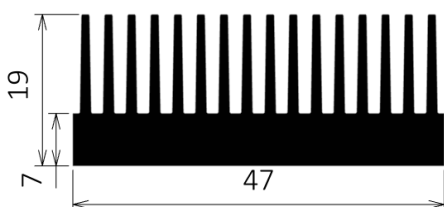

## STANDARD EXTRUDED HEATSINK FOR ALUMINUM

RX580-075-00

Material	AL6063-T5
Weight	1.8 kg/meter

Other lengths and hole patterns on customer request.

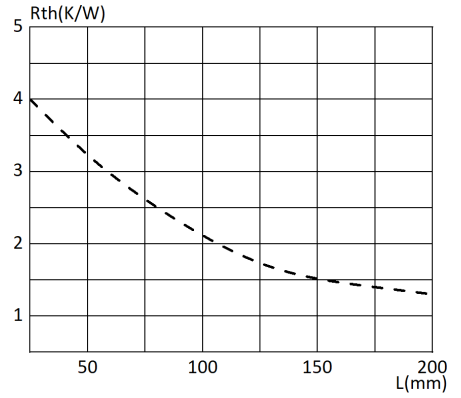
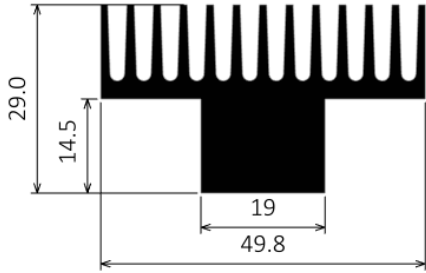

RX580-164-00

Material	AL6063-T5
Weight	0.8 kg/meter

Other lengths and hole patterns on customer request.

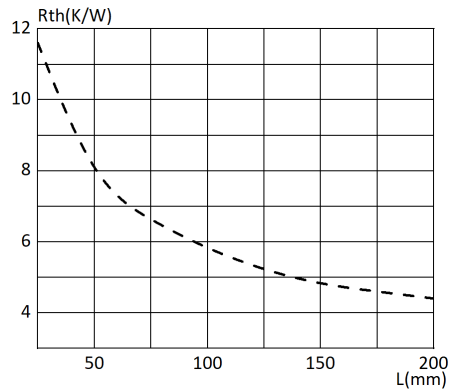
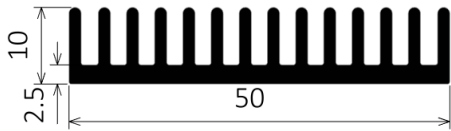

RX580-127-00

Material	AL6063-T5
Weight	1.03 kg/meter

Other lengths and hole patterns on customer request.

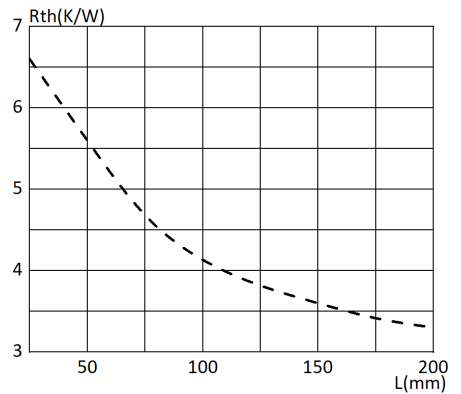
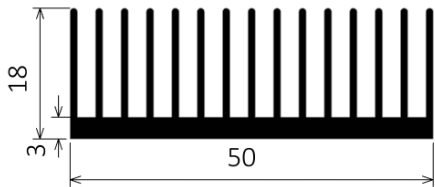

RX580-143-00

Material	AL6063-T5
Weight	0.96 kg/meter

Other lengths and hole patterns on customer request.

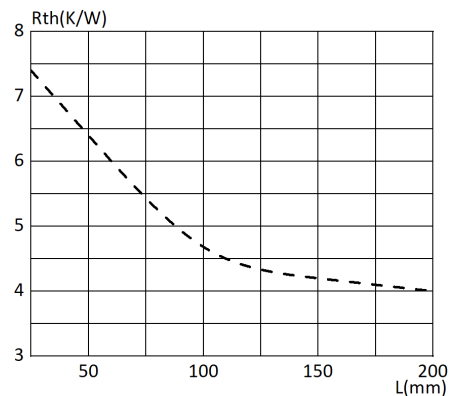

## STANDARD EXTRUDED HEATSINK FOR ALUMINUM

**RX580-157-00**

Material	AL6063-T5
Weight	1.6 kg/meter

Other lengths and hole patterns on customer request.

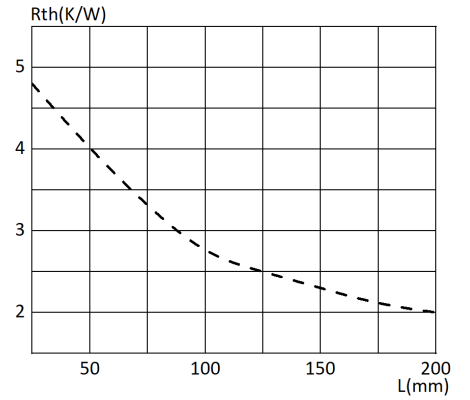
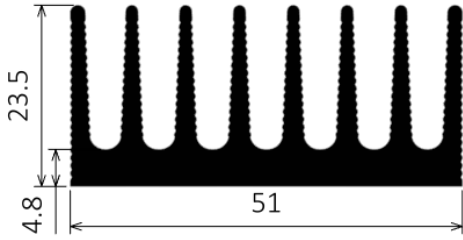

**RX580-216-00**

Material	AL6063-T5
Weight	1.82 kg/meter

Other lengths and hole patterns on customer request.

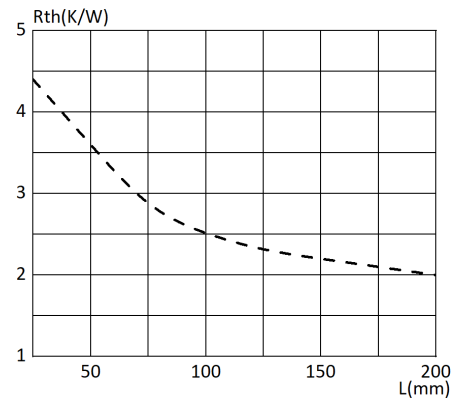
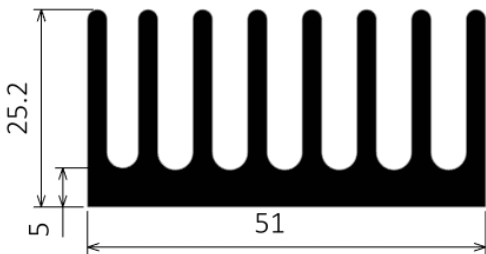

**RX580-129-00**

Material	AL6063-T5
Weight	1.31 kg/meter

Other lengths and hole patterns on customer request.

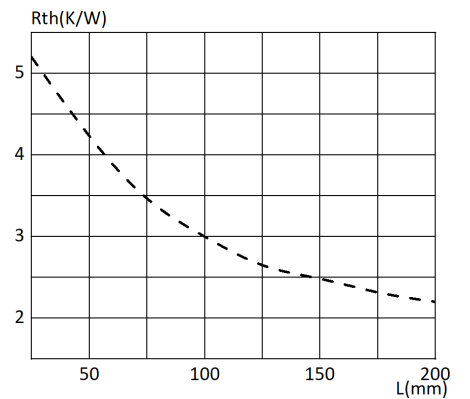
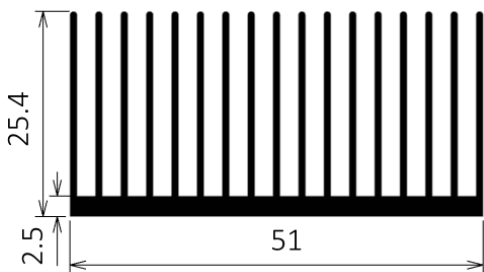

**RX580-051-00**

Material	AL6063-T5
Weight	1.05 kg/meter

Other lengths and hole patterns on customer request.

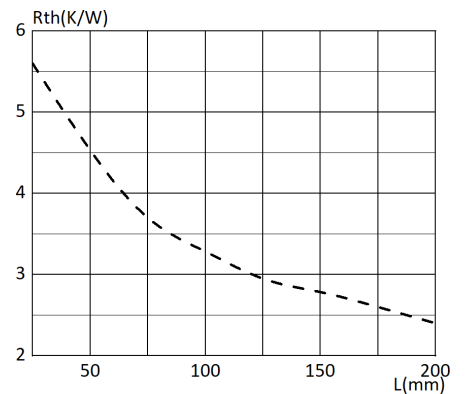
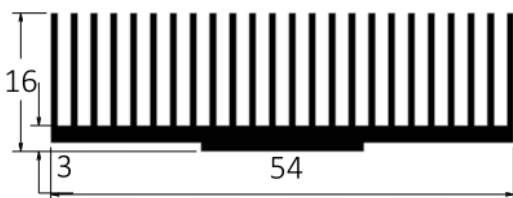



## STANDARD EXTRUDED HEATSINK FOR ALUMINUM

RX580-079-00

Material	AL6063-T5
Weight	0.78 kg/meter

Other lengths and hole patterns on customer request.

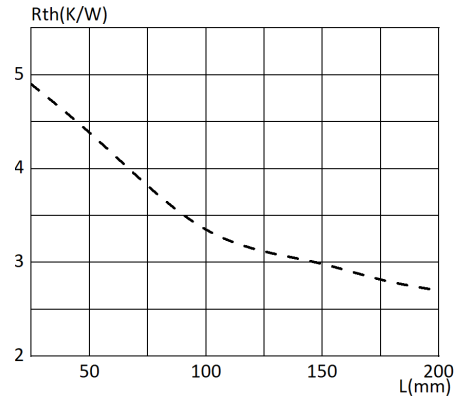
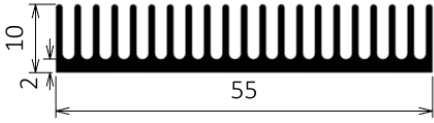

RX580-080-00

Material	AL6063-T5
Weight	0.61 kg/meter

Other lengths and hole patterns on customer request.

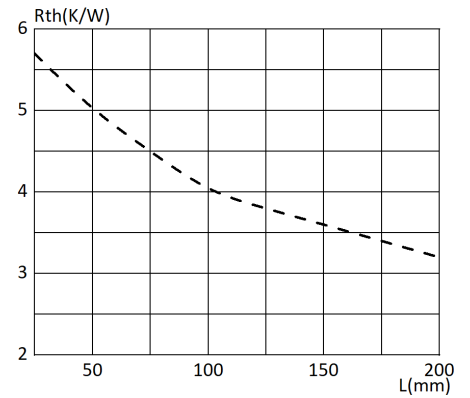

RX580-206-00

Material	AL6063-T5
Weight	1.97 kg/meter

Other lengths and hole patterns on customer request.

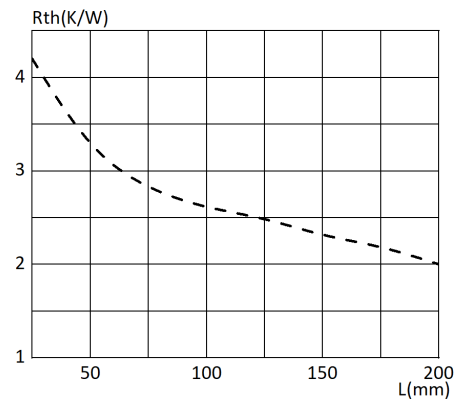
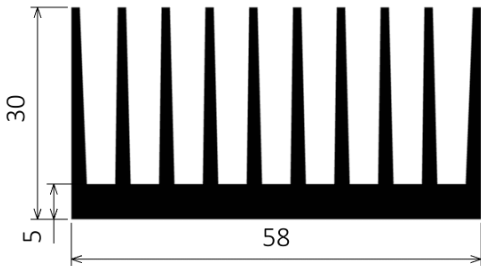

RX580-174-00

Material	AL6063-T5
Weight	2.88 kg/meter

Other lengths and hole patterns on customer request.

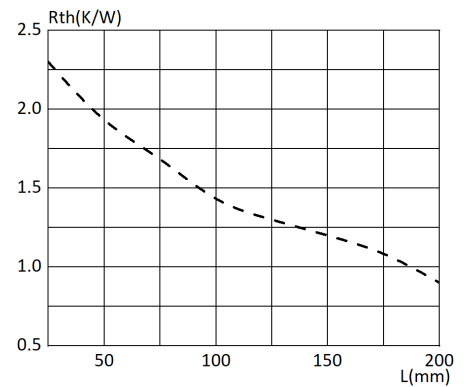
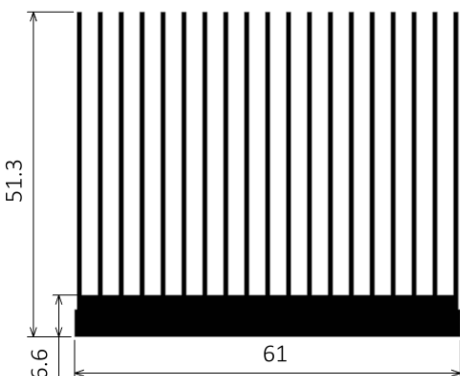

## STANDARD EXTRUDED HEATSINK FOR ALUMINUM

RX580-089-00

Material	AL6063-T5
Weight	1.1 kg/meter

Other lengths and hole patterns on customer request.

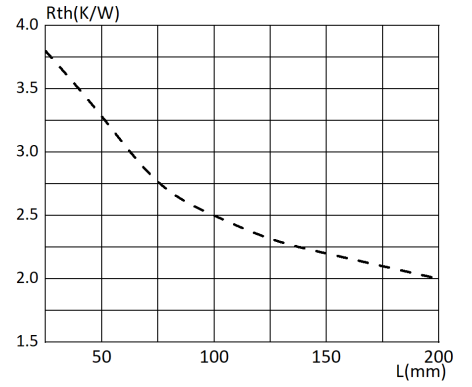
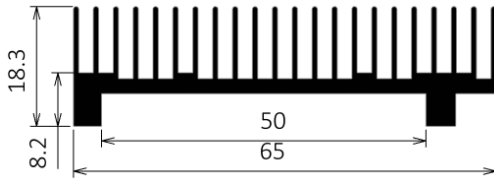

RX580-159-00

Material	AL6063-T5
Weight	1.85 kg/meter

Other lengths and hole patterns on customer request.

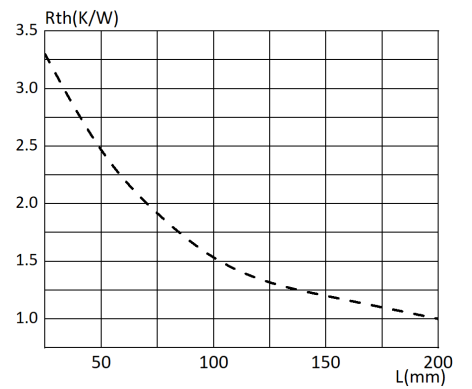
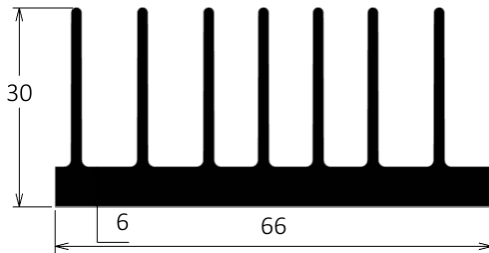

RX580-074-00

Material	AL6063-T5
Weight	3.7 kg/meter

Other lengths and hole patterns on customer request.

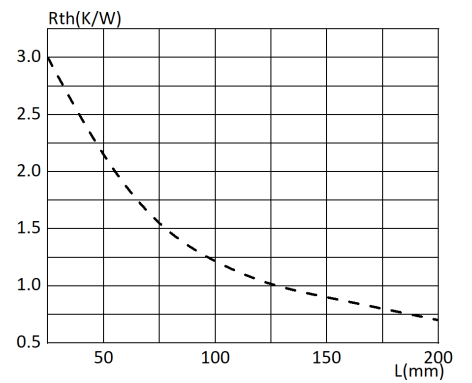
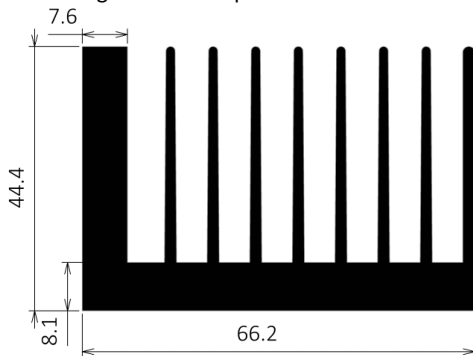

RX580-058-00

Material	AL6063-T5
Weight	1.1 kg/meter

Other lengths and hole patterns on customer request.

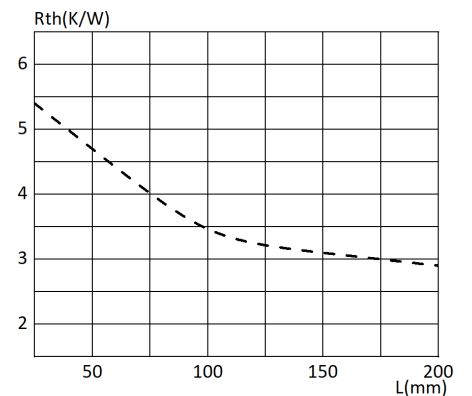
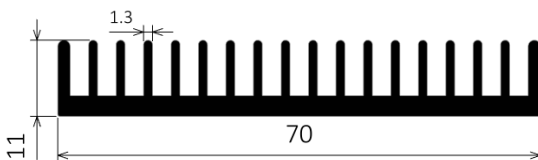

## STANDARD EXTRUDED HEATSINK FOR ALUMINUM

RX580-121-00

Material	AL6063-T5
Weight	2.4 kg/meter

Other lengths and hole patterns on customer request.

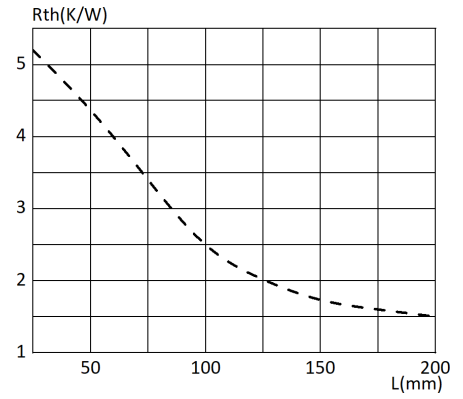
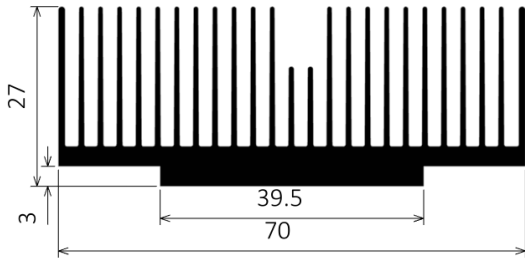

RX580-173-00

Material	AL6063-T5
Weight	2.43 kg/meter

Other lengths and hole patterns on customer request.

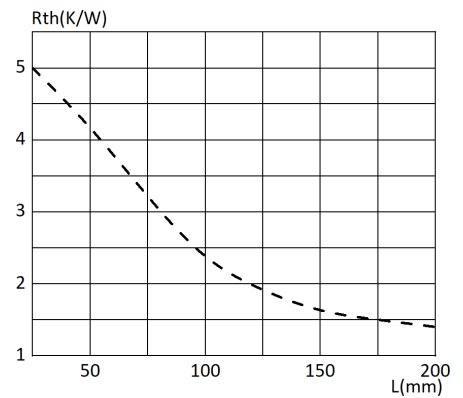
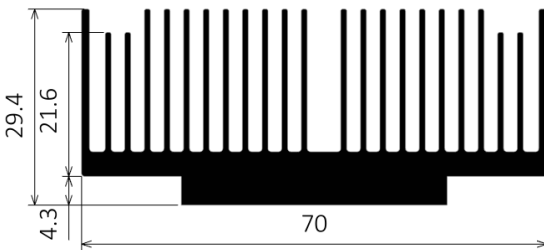

RX580-041-00

Material	AL6063-T5
Weight	3.2 kg/meter

Other lengths and hole patterns on customer request.

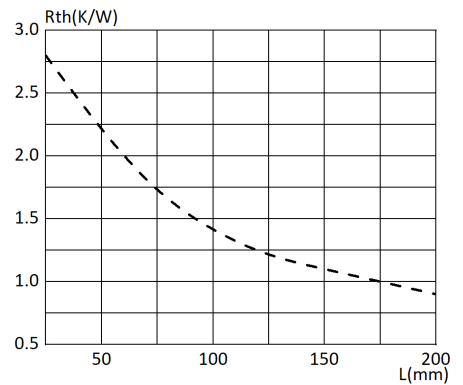

RX580-158-00

Material	AL6063-T5
Weight	1.06 kg/meter

Other lengths and hole patterns on customer request.

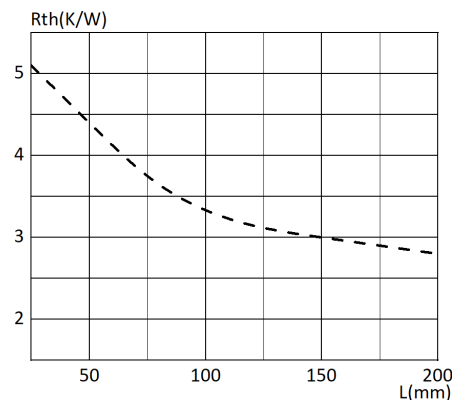
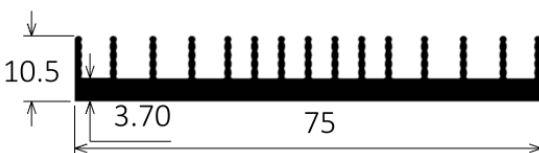

## STANDARD EXTRUDED HEATSINK FOR ALUMINUM

**RX580-193-00**

<b>Material</b>	<b>AL6063-T5</b>
<b>Weight</b>	<b>0.96 kg/meter</b>

Other lengths and hole patterns on customer request.

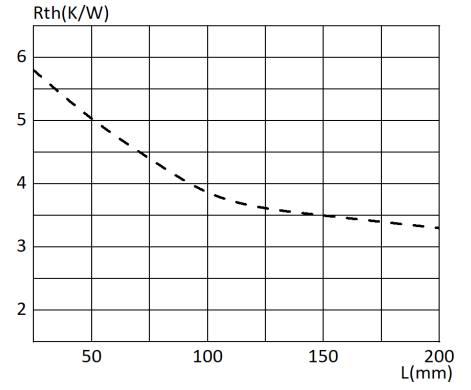
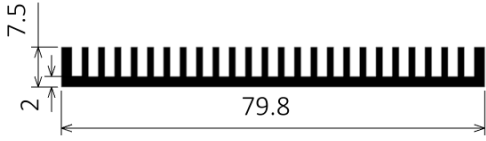

**RX580-145-00**

<b>Material</b>	<b>AL6063-T5</b>
<b>Weight</b>	<b>1.55 kg/meter</b>

Other lengths and hole patterns on customer request.

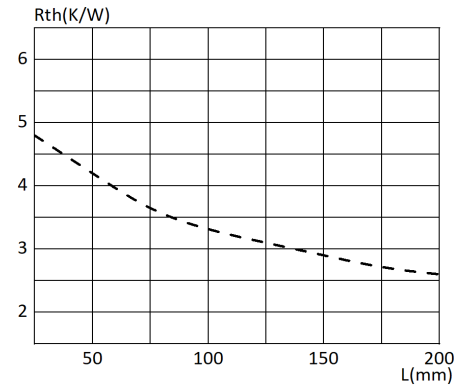
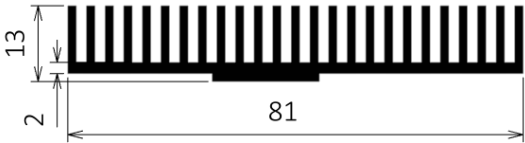

**RX580-128-00**

<b>Material</b>	<b>AL6063-T5</b>
<b>Weight</b>	<b>1.72 kg/meter</b>

Other lengths and hole patterns on customer request.

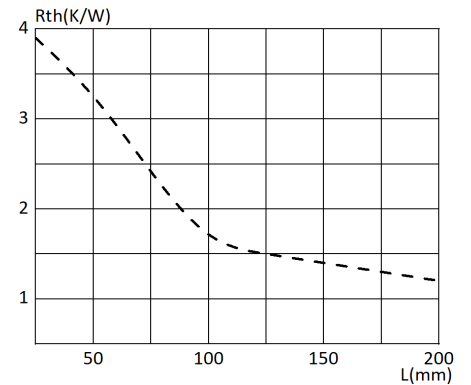
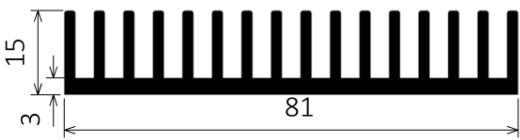

**RX580-135-00**

<b>Material</b>	<b>AL6063-T5</b>
<b>Weight</b>	<b>1.29 kg/meter</b>

Other lengths and hole patterns on customer request.

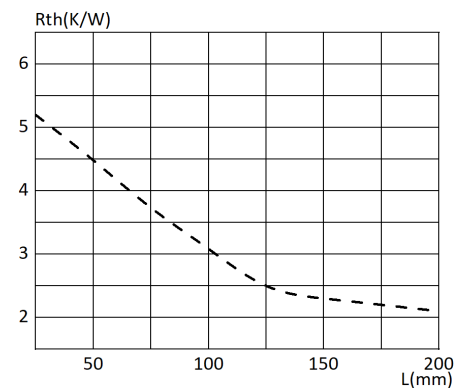
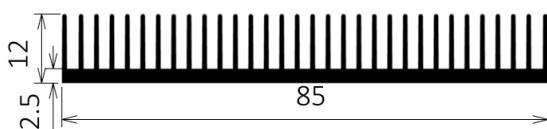

## STANDARD EXTRUDED HEATSINK FOR ALUMINUM

RX580-171-00

Material	AL6063-T5
Weight	2.12 kg/meter

Other lengths and hole patterns on customer request.

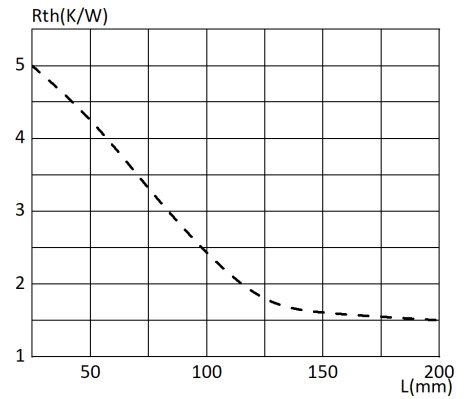
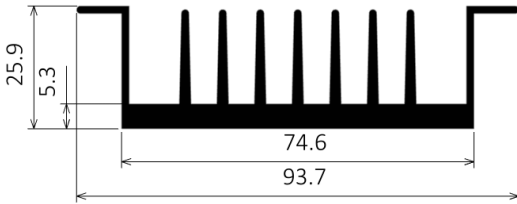

RX580-150-00

Material	AL6063-T5
Weight	5.9 kg/meter

Other lengths and hole patterns on customer request.

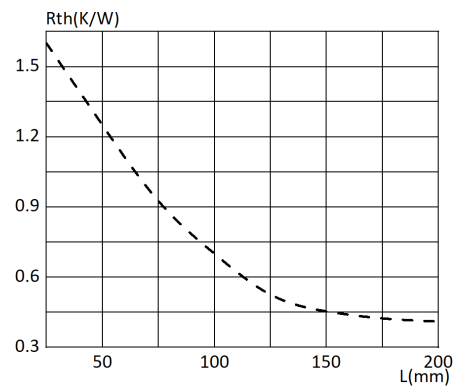
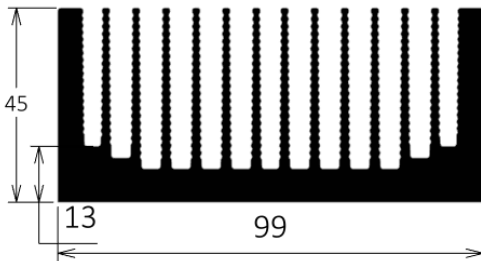

RX580-151-00

Material	AL6063-T5
Weight	1.4 kg/meter

Other lengths and hole patterns on customer request.

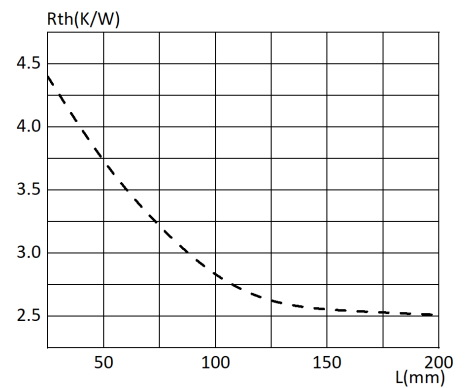
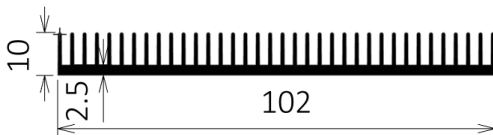

RX580-053-00

Material	AL6063-T5
Weight	3.4 kg/meter

Other lengths and hole patterns on customer request.

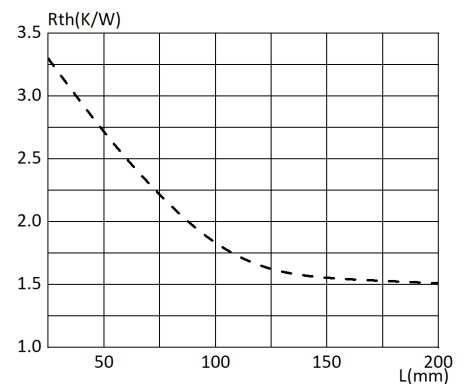
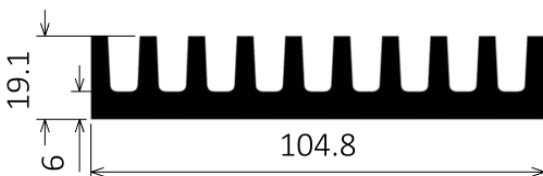

## STANDARD EXTRUDED HEATSINK FOR ALUMINUM

RX580-152-00

Material	AL6063-T5
Weight	5.5 kg/meter

Other lengths and hole patterns on customer request.

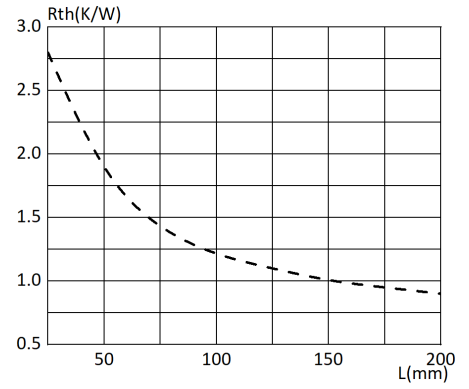
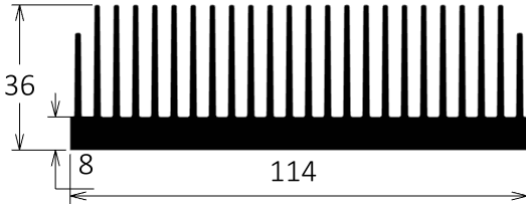

RX580-225-00

Material	AL6063-T5
Weight	1.3 kg/meter

Other lengths and hole patterns on customer request.

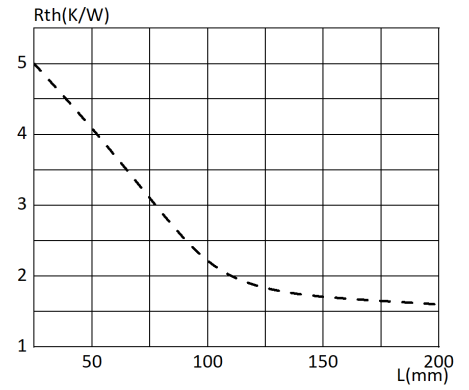
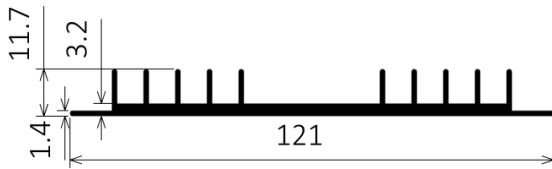

RX580-134-00

Material	AL6063-T5
Weight	4.86 kg/meter

Other lengths and hole patterns on customer request.

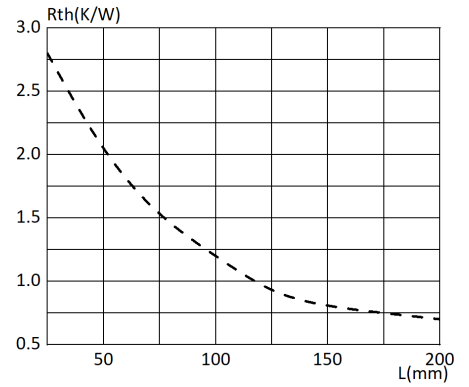
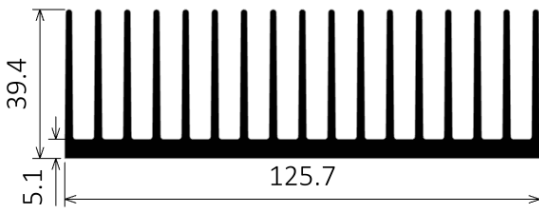

RX580-005-00

Material	AL6063-T5
Weight	3.1 kg/meter

Other lengths and hole patterns on customer request.

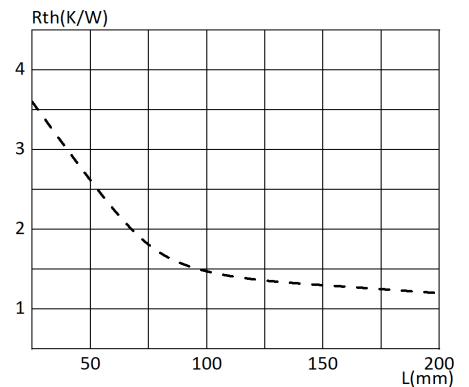
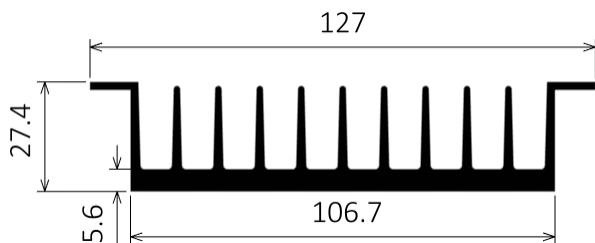

## STANDARD EXTRUDED HEATSINK FOR ALUMINUM

RX580-024-00

Material	AL6063-T5
Weight	5.3 kg/meter

Other lengths and hole patterns on customer request.

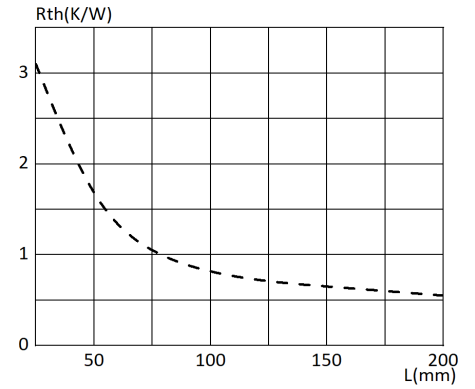

RX580-087-00

Material	AL6063-T5
Weight	4.9 kg/meter

Other lengths and hole patterns on customer request.

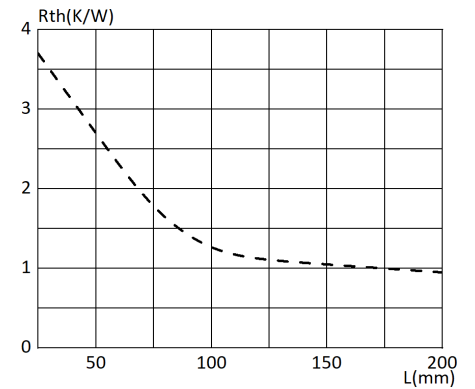
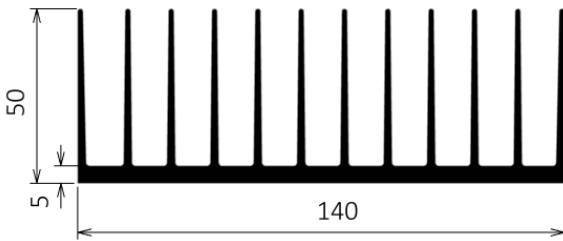

RX580-109-00

Material	AL6063-T5
Weight	6.2 kg/meter

Other lengths and hole patterns on customer request.

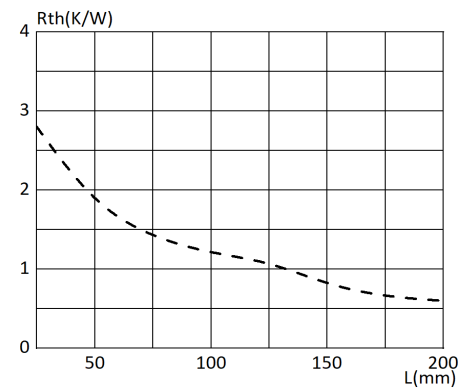

RX580-126-00

Material	AL6063-T5
Weight	1.83 kg/meter

Other lengths and hole patterns on customer request.

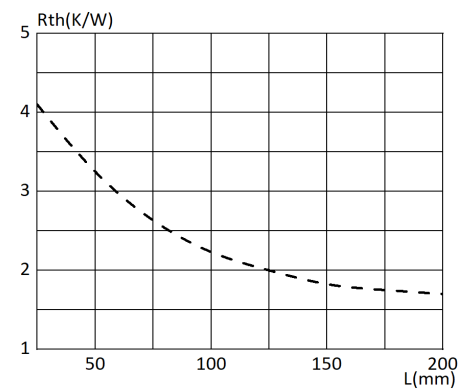

## STANDARD EXTRUDED HEATSINK FOR ALUMINUM

**RX580-154-00**

<b>Material</b>	<b>AL6063-T5</b>
<b>Weight</b>	<b>8.2 kg/meter</b>

Other lengths and hole patterns on customer request.

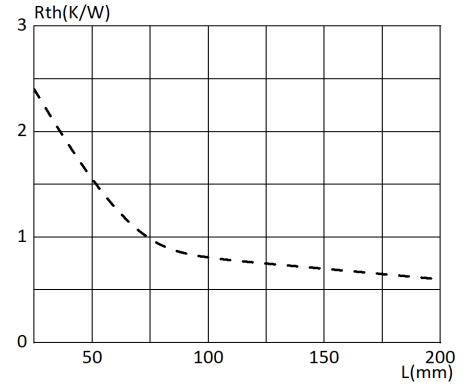
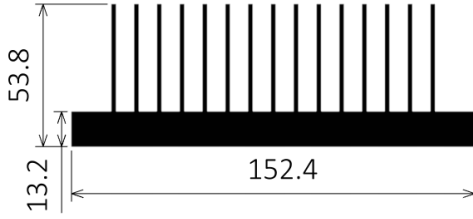

**RX580-103-00**

<b>Material</b>	<b>AL6063-T5</b>
<b>Weight</b>	<b>8.8 kg/meter</b>

Other lengths and hole patterns on customer request.

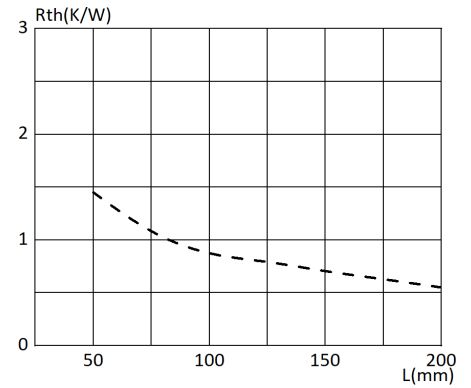
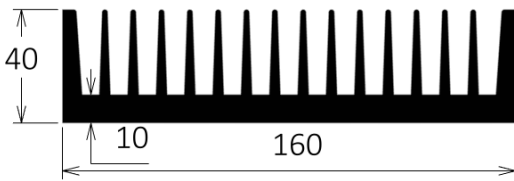

**RX580-100-00**

<b>Material</b>	<b>AL6063-T5</b>
<b>Weight</b>	<b>8.72 kg/meter</b>

Other lengths and hole patterns on customer request.

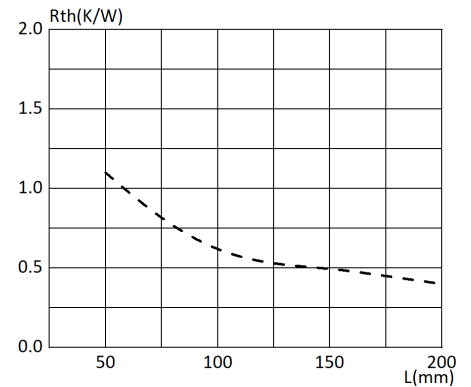
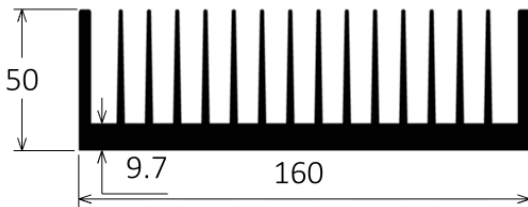

**RX580-165-00**

<b>Material</b>	<b>AL6063-T5</b>
<b>Weight</b>	<b>11.32 kg/meter</b>

Other lengths and hole patterns on customer request.

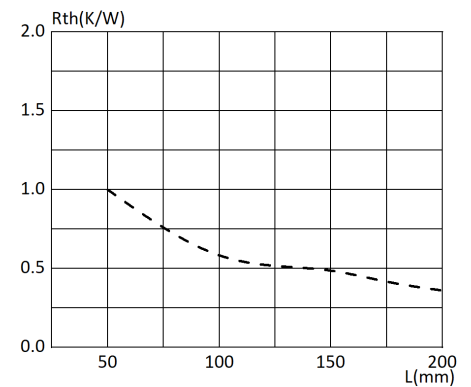
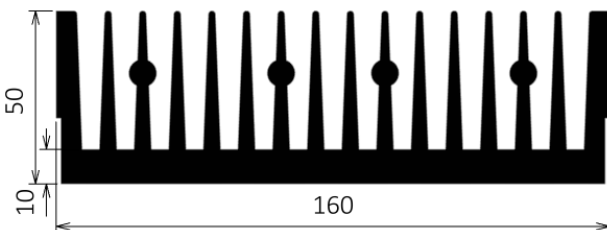



## STANDARD EXTRUDED HEATSINK FOR ALUMINUM

RX581-146-00

Material	AL6063-T5
Weight	16.68 kg/meter

Other lengths and hole patterns on customer request.

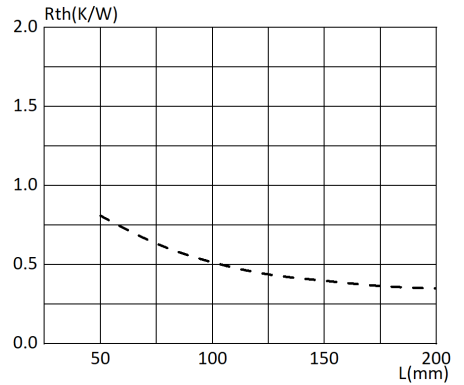
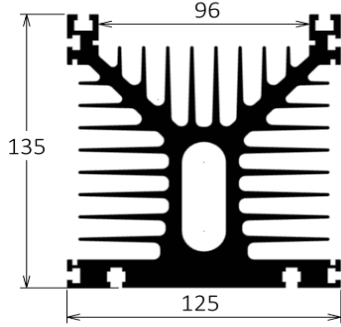

RX580-108-00

Material	AL6063-T5
Weight	9.5 kg/meter

Other lengths and hole patterns on customer request.

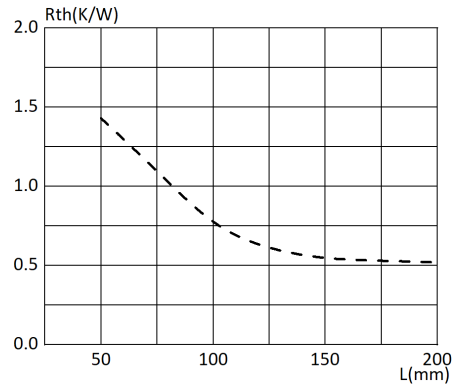
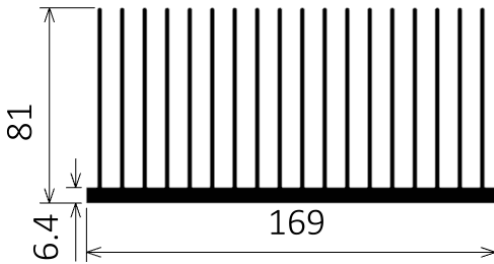

RX580-131-00

Material	AL6063-T5
Weight	9.86 kg/meter

Other lengths and hole patterns on customer request.

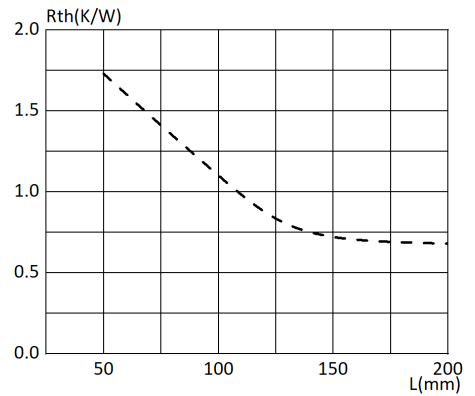
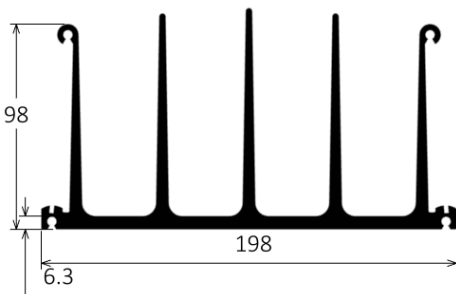

RX580-049-00

Material	AL6063-T5
Weight	3.0 kg/meter

Other lengths and hole patterns on customer request.

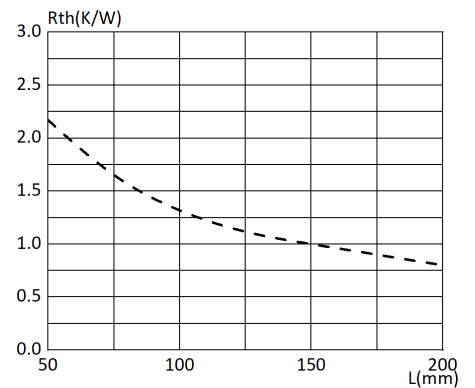
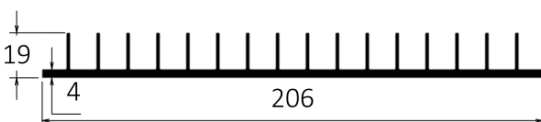

## STANDARD EXTRUDED HEATSINK FOR ALUMINUM

RX580-042-00

Material	AL6063-T5
Weight	9.27 kg/meter

Other lengths and hole patterns on customer request.

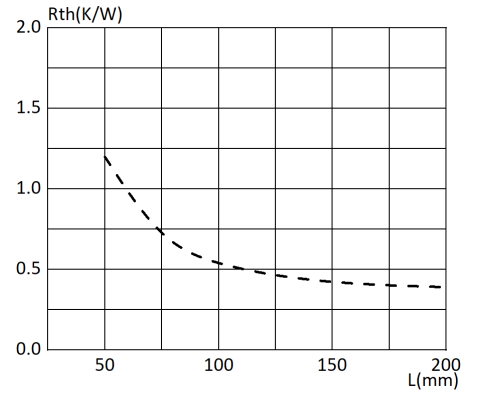
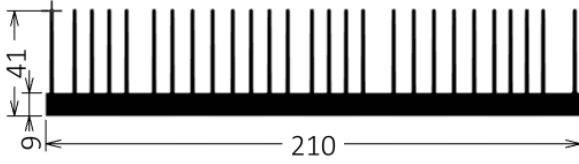

RX580-167-00

Material	AL6063-T5
Weight	16.36 kg/meter

Other lengths and hole patterns on customer request.

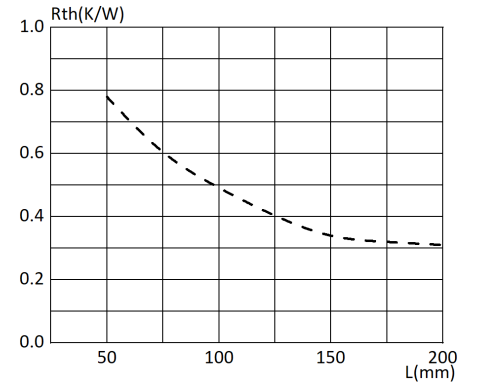
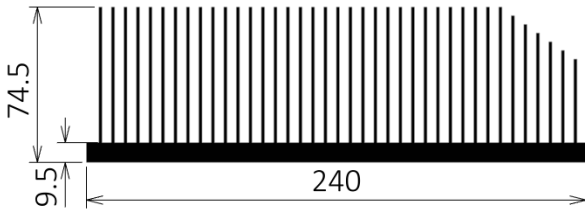

RX580-023-00

Material	AL6063-T5
Weight	21.2 kg/meter

Other lengths and hole patterns on customer request.

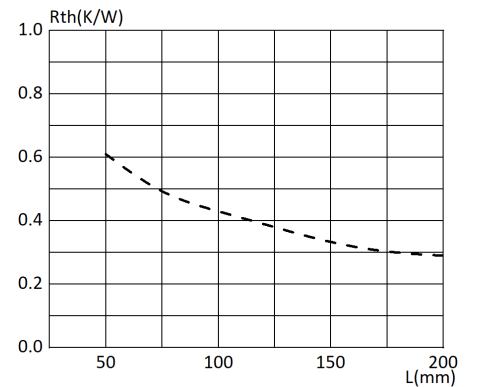

RX580-102-00

Material	AL6063-T5
Weight	12.1 kg/meter

Other lengths and hole patterns on customer request.

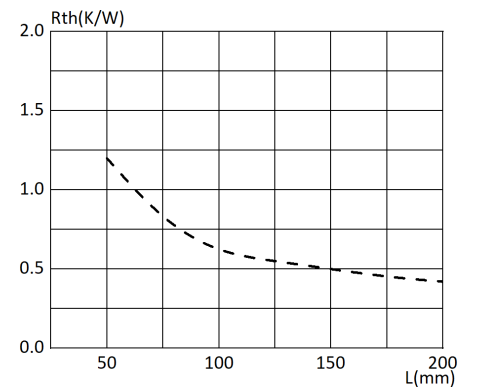

## STANDARD EXTRUDED HEATSINK FOR ALUMINUM

RX580-138-00

Material	AL6063-T5
Weight	16.83 kg/meter

Other lengths and hole patterns on customer request.

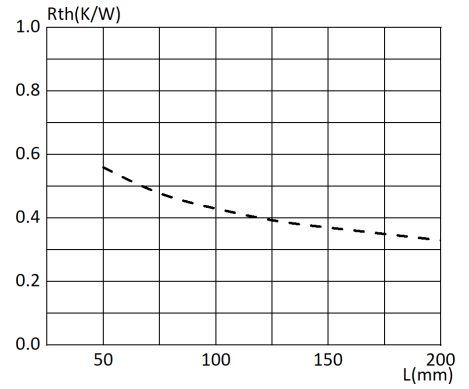
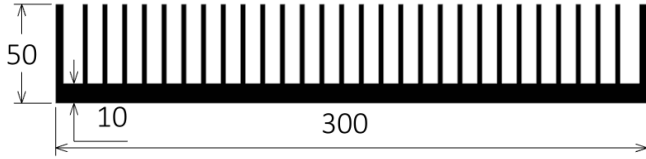

RX580-156-00

Material	AL6063-T5
Weight	11.5 kg/meter

Other lengths and hole patterns on customer request.

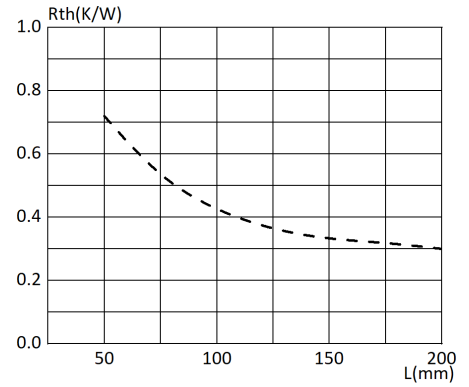
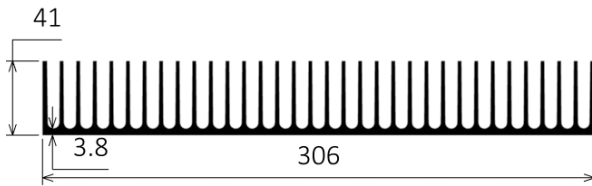

RX580-162-00

Material	AL6063-T5
Weight	28.54 kg/meter

Other lengths and hole patterns on customer request.

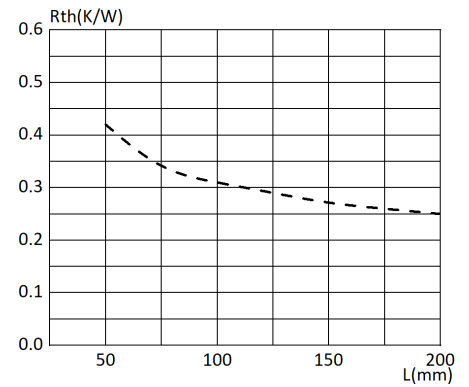
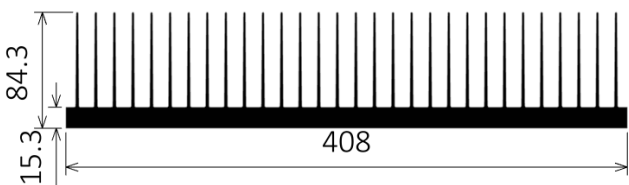

RX580-163-00

Material	AL6063-T5
Weight	27.23 kg/meter

Other lengths and hole patterns on customer request.

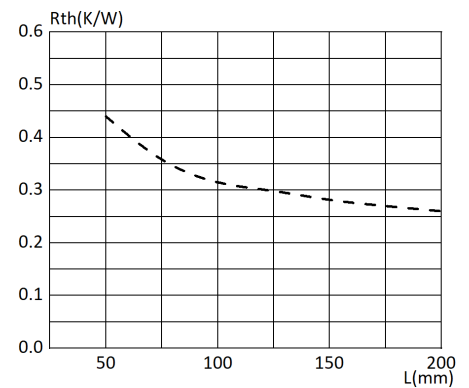
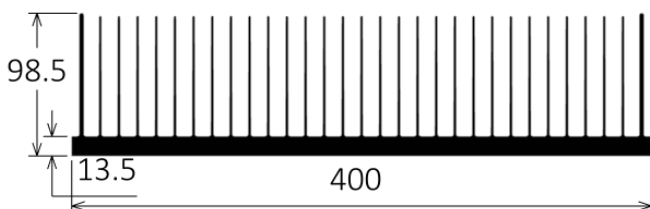

## STANDARD EXTRUDED HEATSINK FOR ALUMINUM

**RX580-160-00**

Material	AL6063-T5
Weight	34.1 kg/meter

Other lengths and hole patterns on customer request.

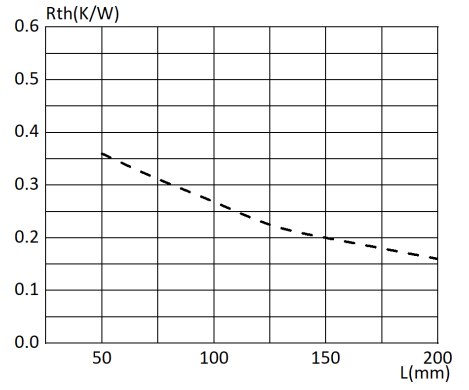

**RX580-161-00**

Material	AL6063-T5
Weight	32.3 kg/meter

Other lengths and hole patterns on customer request.

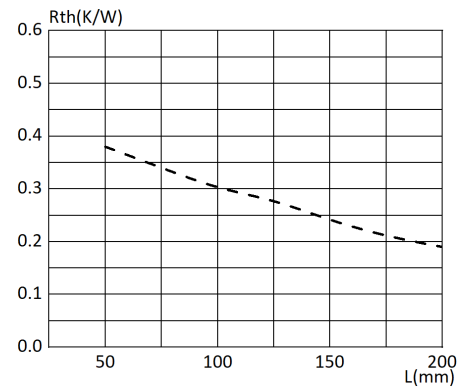

## EXTRUDED PROFILES HEATSINK FOR LED 'S

RX582-001-00

Material	AL6063-T5
Weight	0.85 kg/meter

Other lengths and hole patterns on customer request.

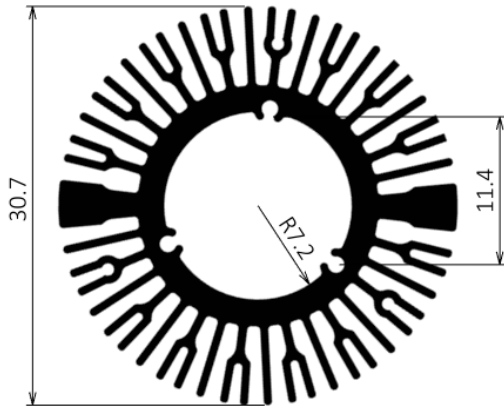

RX582-002-00

Material	AL6063-T5
Weight	1.17 kg/meter

Other lengths and hole patterns on customer request.

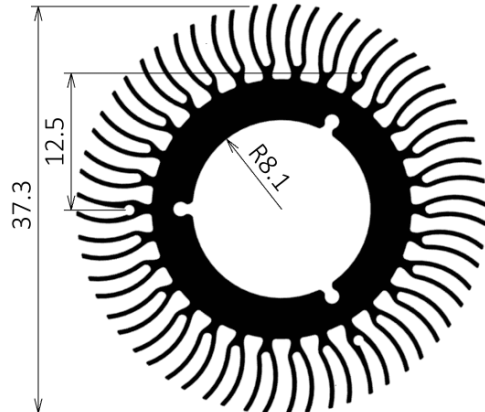

RX582-003-00

Material	AL6063-T5
Weight	4.98 kg/meter

Other lengths and hole patterns on customer request.

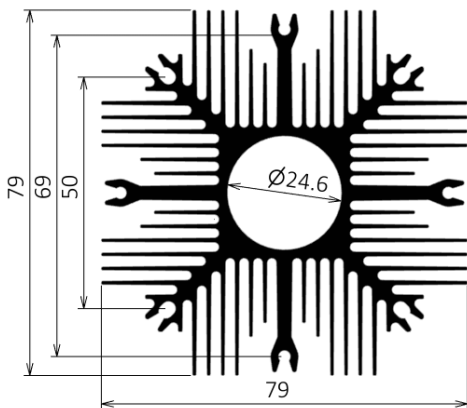

RX582-004-00

Material	AL6063-T5
Weight	1.9 kg/meter

Other lengths and hole patterns on customer request.

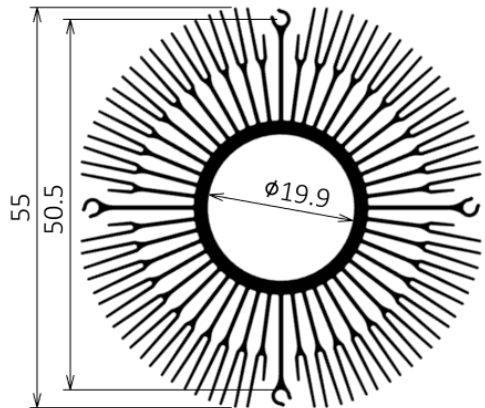

RX582-005-00

Material	AL6063-T5
Weight	2.0 kg/meter

Other lengths and hole patterns on customer request.

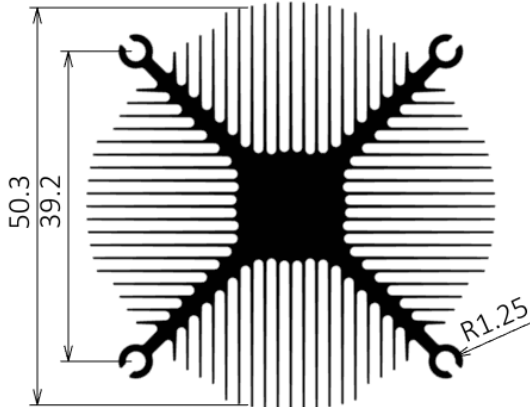

RX582-006-00

Material	AL6063-T5
Weight	2.94 kg/meter

Other lengths and hole patterns on customer request.

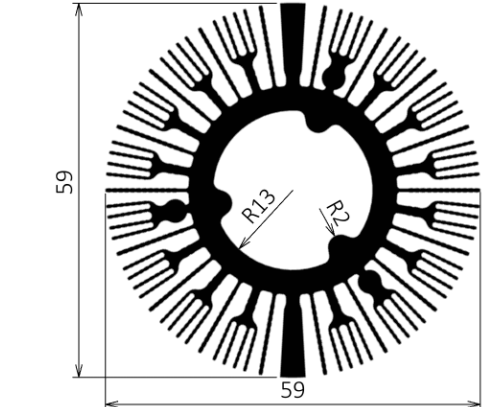

## EXTRUDED PROFILES HEATSINK FOR LED 'S

RX582-007-00

Material	AL6063-T5
Weight	0.84 kg/meter

Other lengths and hole patterns on customer request.

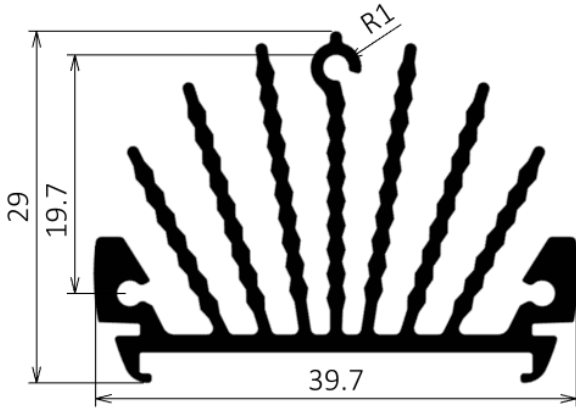

RX582-009-00

Material	AL6063-T5
Weight	1.82 kg/meter

Other lengths and hole patterns on customer request.

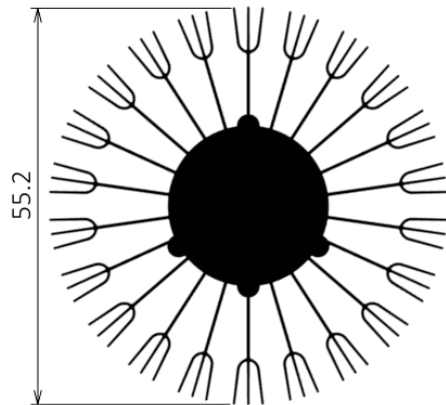

RX582-011-00

Material	AL6063-T5
Weight	15.9 kg/meter

Other lengths and hole patterns on customer request.

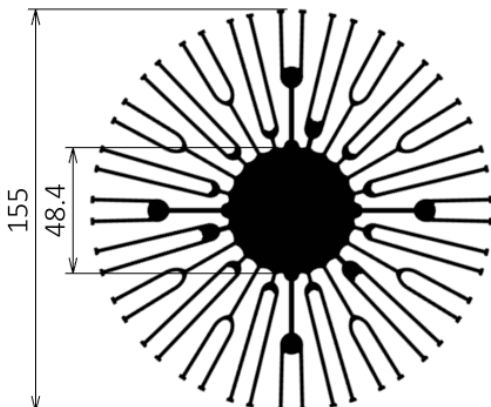

RX582-008-00

Material	AL6063-T5
Weight	1.9 kg/meter

Other lengths and hole patterns on customer request.

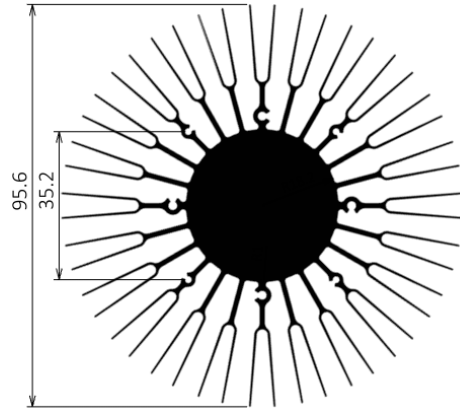

RX582-010-00

Material	AL6063-T5
Weight	1.9 kg/meter

Other lengths and hole patterns on customer request.

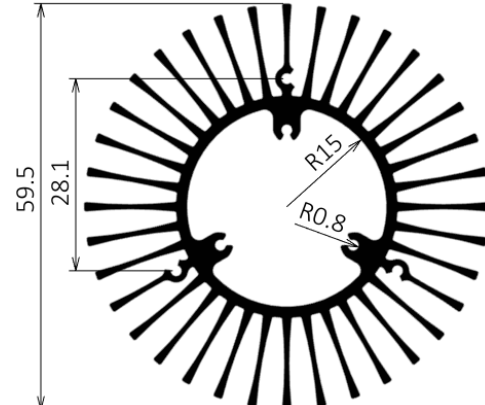

RX582-012-00

Material	AL6063-T5
Weight	0.85 kg/meter

Other lengths and hole patterns on customer request.

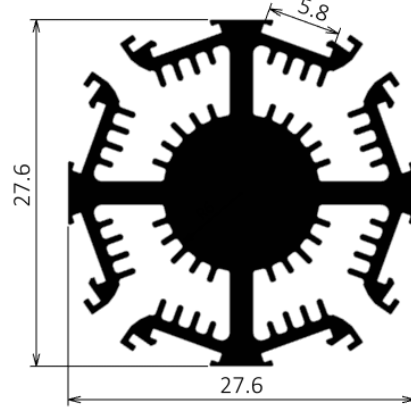

## EXTRUDED PROFILES HEATSINK FOR LED 'S

**RX582-013-00**

Material	AL6063-T5
Weight	2.67 kg/meter

Other lengths and hole patterns on customer request.

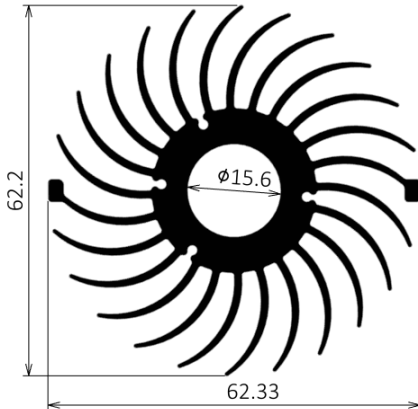

**RX582-015-00**

Material	AL6063-T5
Weight	21.5 kg/meter

Other lengths and hole patterns on customer request.

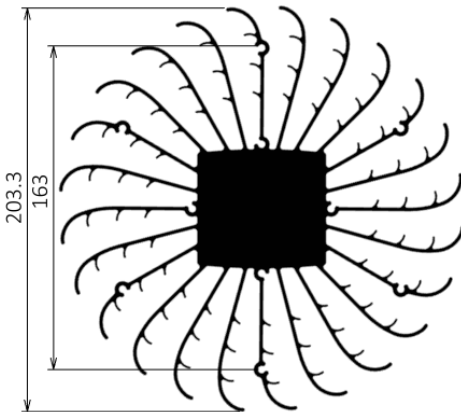

**RX582-017-00**

Material	AL6063-T5
Weight	3.5 kg/meter

Other lengths and hole patterns on customer request.

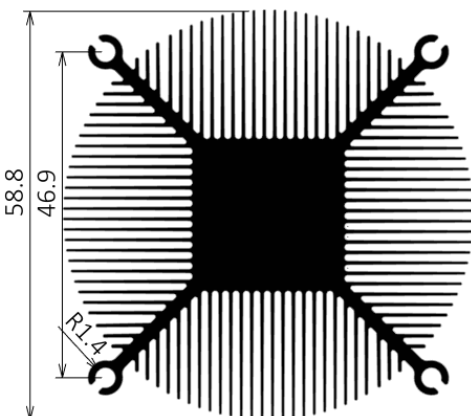

**RX582-014-00**

Material	AL6063-T5
Weight	11.1 kg/meter

Other lengths and hole patterns on customer request.

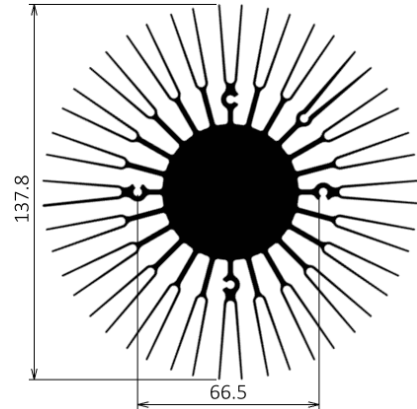

**RX582-016-00**

Material	AL6063-T5
Weight	1.96 kg/meter

Other lengths and hole patterns on customer request.

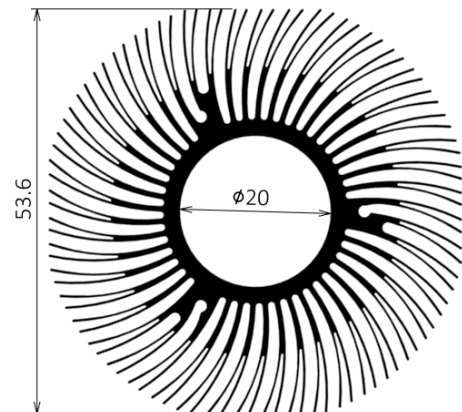

**RX582-018-00**

Material	AL6063-T5
Weight	0.66 kg/meter

Other lengths and hole patterns on customer request.

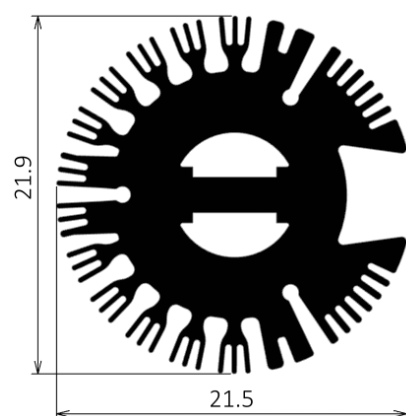



# CASE

**Heat dissipating case**

**Combination cases**

**Plug-in box with cooling fins**

**19" insert modules with 19" plug-in boxes**

**Front panels with Tube cases**



## HEATS DISSIPATING CASE

RX590-010-00

Material	AL6063-T5
Weight	3.01 kg/meter

Other lengths and hole patterns on customer request.

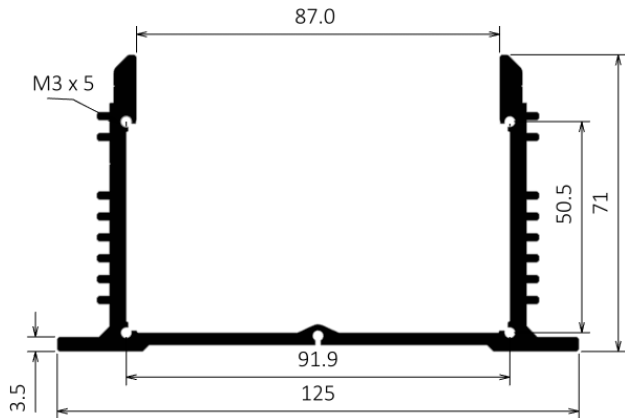

RX580-769-00

Material	AL6063-T5
Weight	0.4 kg/meter

Other lengths and hole patterns on customer request.

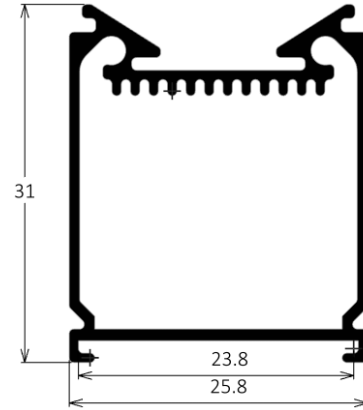

RX582-191-00

Material	AL6063-T5
Weight	1.72 kg/meter

Other lengths and hole patterns on customer request.

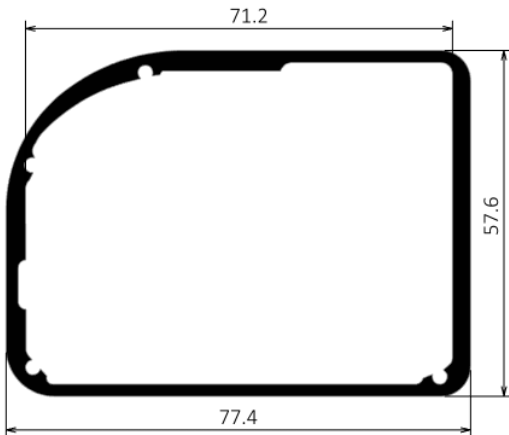

RX582-016-00

Material	AL6063-T5
Weight	1.96 kg/meter

Other lengths and hole patterns on customer request.

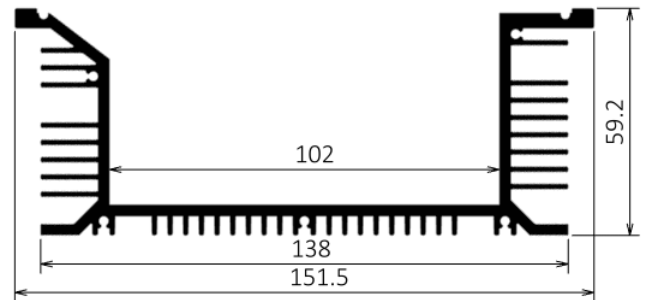

RX580-029-00

Material	AL6063-T5
Weight	5.2 kg/meter

Other lengths and hole patterns on customer request.

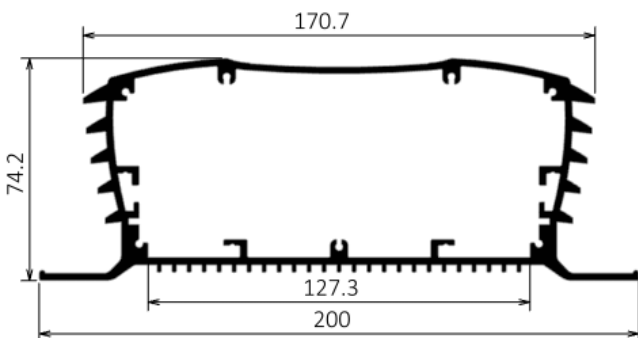

RX580-028-00

Material	AL6063-T5
Weight	2.65 kg/meter

Other lengths and hole patterns on customer request.

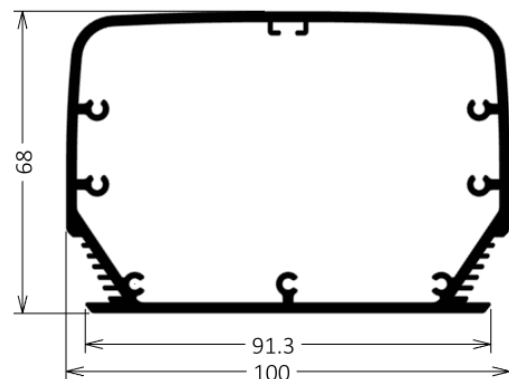

## HEATS DISSIPATING CASE

RX580-035-00

Material	AL6063-T5
Weight	4.54 kg/meter

Other lengths and hole patterns on customer request.

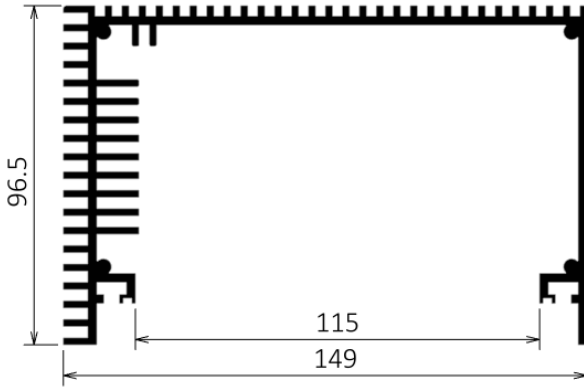

RX580-044-00

Material	AL6063-T5
Weight	1.4 kg/meter

Other lengths and hole patterns on customer request.

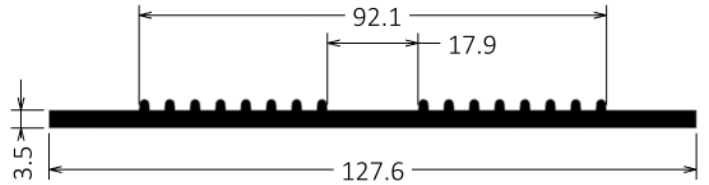

RX580-045-00

Material	AL6063-T5
Weight	1.98 kg/meter

Other lengths and hole patterns on customer request.

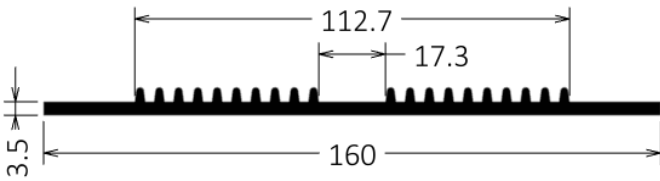

RX580-054-00

Material	AL6063-T5
Weight	5.1 kg/meter

Other lengths and hole patterns on customer request.

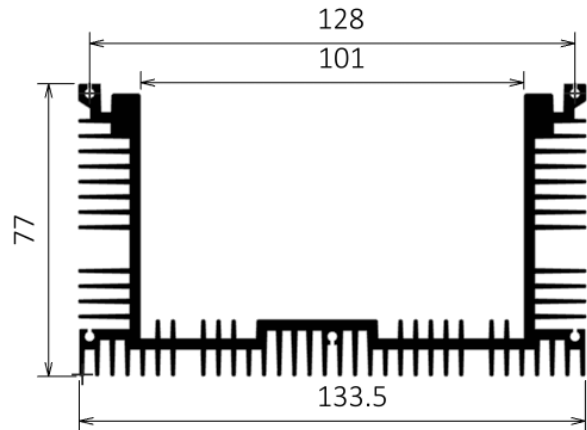

RX580-059-00

Material	AL6063-T5
Weight	3.85 kg/meter

Other lengths and hole patterns on customer request.

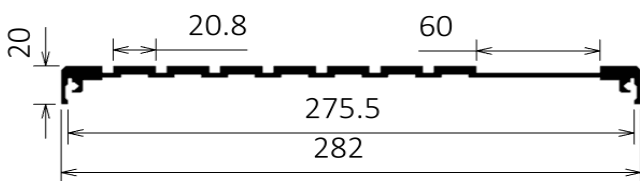

RX580-060-00

Material	AL6063-T5
Weight	3.6 kg/meter

Other lengths and hole patterns on customer request.

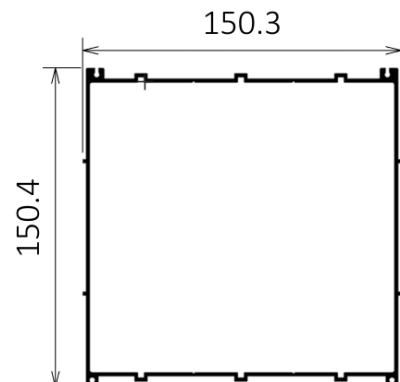

## HEATS DISSIPATING CASE

**RX580-141-00**

Material	AL6063-T5
Weight	6.88 kg/meter

Other lengths and hole patterns on customer request.

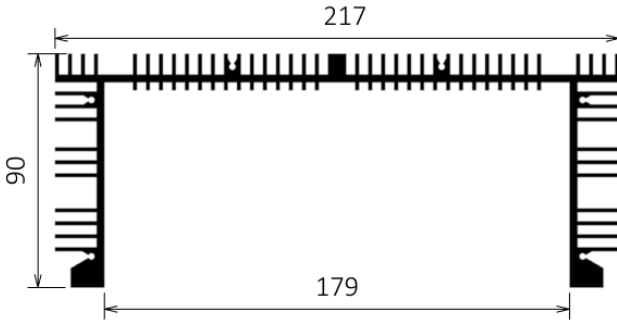

**RX580-187-00**

Material	AL6063-T5
Weight	4.07 kg/meter

Other lengths and hole patterns on customer request.

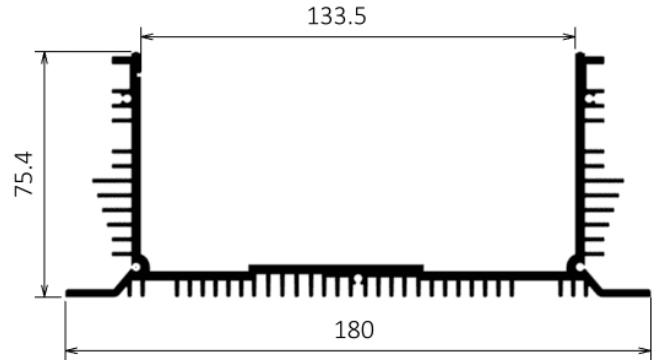

**RX581-055-00**

Material	AL6063-T5
Weight	5.06 kg/meter

Other lengths and hole patterns on customer request.

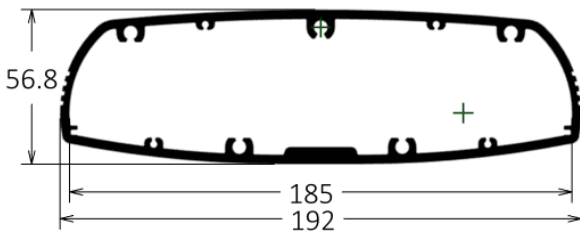

**RX580-056-00**

Material	AL6063-T5
Weight	3.9 kg/meter

Other lengths and hole patterns on customer request.

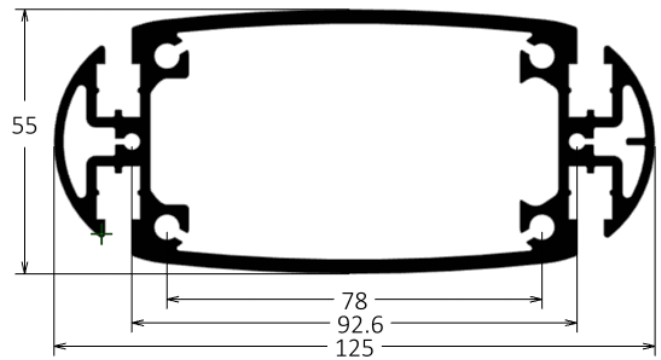

**RX581-057-00**

Material	AL6063-T5
Weight	2.11 kg/meter

Other lengths and hole patterns on customer request.

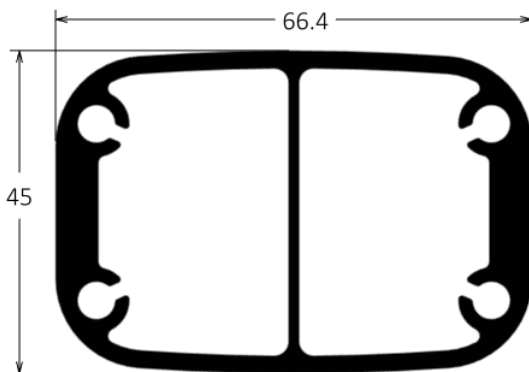

**RX581-058-00**

Material	AL6063-T5
Weight	3.44 kg/meter

Other lengths and hole patterns on customer request.

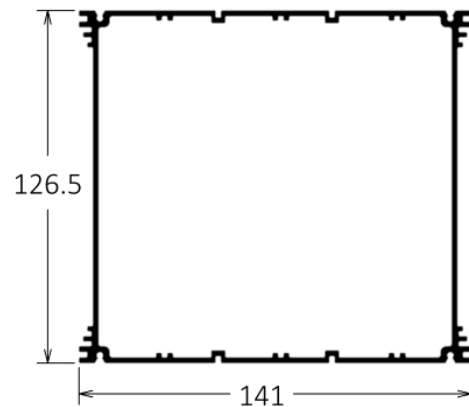

## HEATS DISSIPATING CASE

RX581-059-00

Material	AL6063-T5
Weight	3.78 kg/meter

Other lengths and hole patterns on customer request.

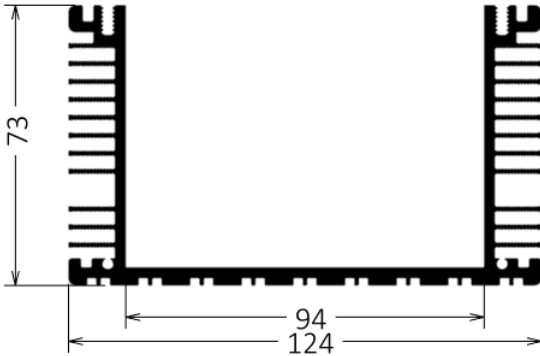

RX581-060-00

Material	AL6063-T5
Weight	7.77 kg/meter

Other lengths and hole patterns on customer request.

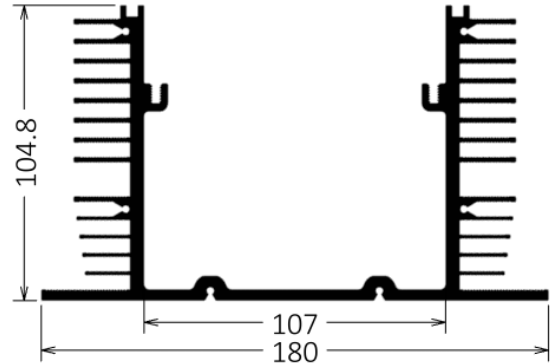

RX581-061-00

Material	AL6063-T5
Weight	6.06 kg/meter

Other lengths and hole patterns on customer request.

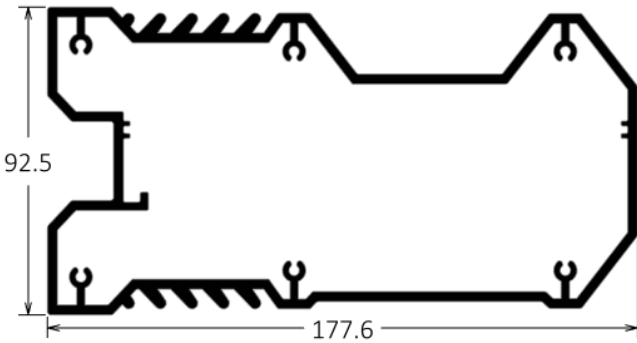

RX581-062-00

Material	AL6063-T5
Weight	4.09 kg/meter

Other lengths and hole patterns on customer request.

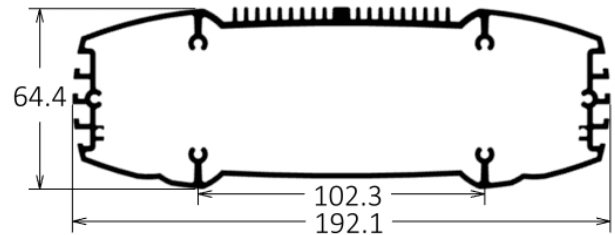

RX581-063-00

Material	AL6063-T5
Weight	2.11 kg/meter

Other lengths and hole patterns on customer request.

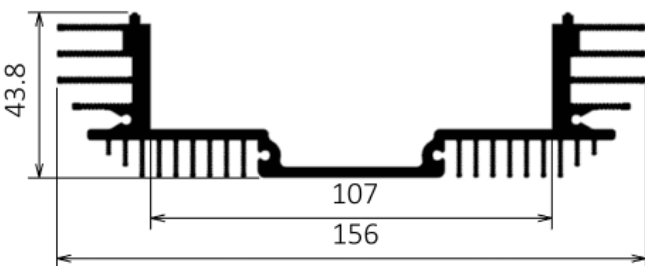

RX581-064-00

Material	AL6063-T5
Weight	7.77 kg/meter

Other lengths and hole patterns on customer request.

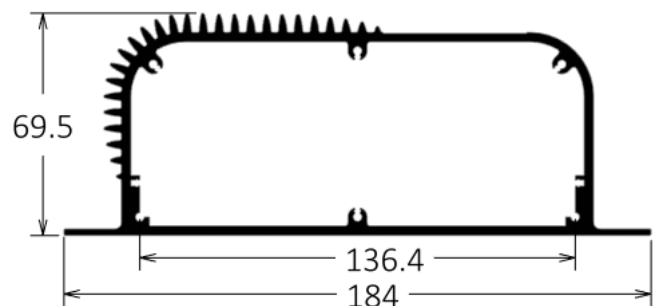

## HEATS DISSIPATING CASE

**RX581-065-00**

Material	AL6063-T5
Weight	4.3 kg/meter

Other lengths and hole patterns on customer request.

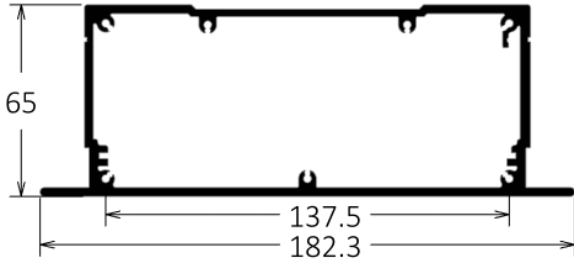

**RX581-066-00**

Material	AL6063-T5
Weight	7.77 kg/meter

Other lengths and hole patterns on customer request.

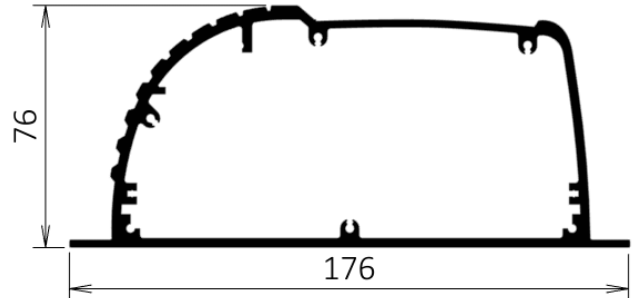

**RX581-067-00**

Material	AL6063-T5
Weight	4.38 kg/meter

Other lengths and hole patterns on customer request.

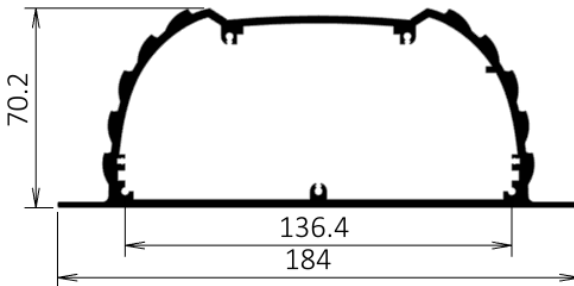

**RX581-068-00**

Material	AL6063-T5
Weight	4.39 kg/meter

Other lengths and hole patterns on customer request.

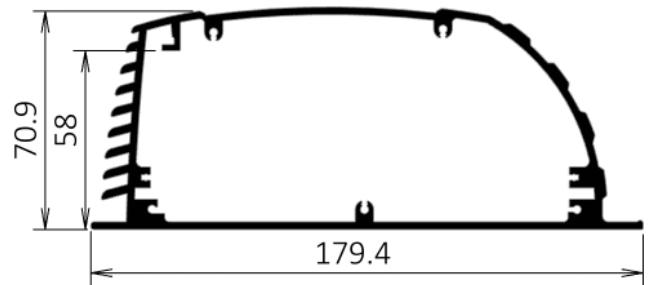

**RX581-070-00**

Material	AL6063-T5
Weight	8.72 kg/meter

Other lengths and hole patterns on customer request.

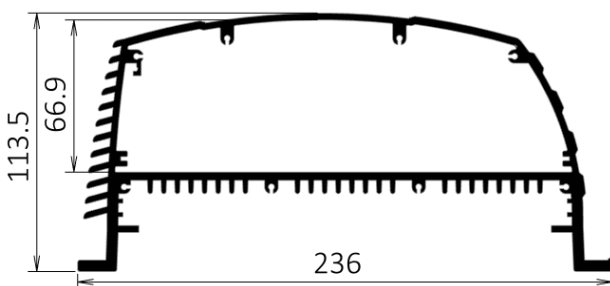

**RX581-069-00**

Material	AL6063-T5
Weight	10.6 kg/meter

Other lengths and hole patterns on customer request.

